

ECONOMIC COMMISSION FOR EUROPE

**RECOMMENDATIONS ON HARMONIZED
EUROPE-WIDE TECHNICAL REQUIREMENTS
FOR INLAND NAVIGATION VESSELS**

Resolution No. 61



UNITED NATIONS

ECONOMIC COMMISSION FOR EUROPE

INLAND TRANSPORT COMMITTEE

Working Party on Inland Water Transport

**Recommendations on Harmonized Europe-Wide
Technical Requirements for Inland Navigation Vessels**

Resolution No. 61



UNITED NATIONS
New York and Geneva, 2006

NOTE

Symbols of United Nations documents are composed of capital letters combined with figures. Mention of such a symbol indicates a reference to a United Nations document.

* * *

The designations employed and the presentation of the material in this publication do not imply the expression of any opinion whatsoever on the part of the Secretariat of the United Nations concerning the legal status of any country, territory, city or area, or of its authorities, or concerning the delimitation of its frontiers or boundaries.

ECE/TRANS/SC.3/172

UNITED NATIONS PUBLICATION

Sales No. E. 06.II.E.7

ISBN 92-1-116941-0

RECOMMENDATIONS ON HARMONIZED EUROPE-WIDE TECHNICAL REQUIREMENTS FOR INLAND NAVIGATION VESSELS

Resolution No. 61
(adopted by the Working Party on Inland Water Transport
on 16 March 2006)

The Working Party on Inland Water Transport,

Considering resolution No. 17, revised (TRANS/SC.3/103, annex 1), containing in its annex the Recommendations on Technical Requirements for Inland Navigation Vessels as amended (TRANS/SC.3/104 and Add.1-6),

Considering also resolution No.33 (TRANS/SC.3/131) on Ship's Certificate,

Recalling the recommendation of the Inland Transport Committee that the Working Party should continue its efforts towards a full reciprocal recognition of ship's certificates and should, to this end, undertake updating the Recommendations on Technical Requirements for Inland Navigation Vessels (ECE/TRANS/97, paragraph 104),

Recalling further the Declaration adopted by the Pan-European Conference on Inland Waterway Transport (Rotterdam, 5-6 September 2001) inviting the European Commission, UNECE and the two river commissions to intensify their cooperation on Pan-European harmonization of technical, safety and manning requirements (TRANS/SC.3/2001/10, point 12),

Believing that the harmonization of national and international (within subregional groupings) technical requirements for vessels applied on European inland waterways would be of great benefit to international transport by inland waterway, the safety of navigation, the protection of human health and life, as well as the protection of the environment,

Bearing in mind the report of the Working Party on the Standardization of Technical and Safety Requirements in Inland Navigation, on its twenty-ninth session in so far as the item on the amendment of the Recommendations on Technical Requirements for Inland Navigation Vessels is concerned (TRANS/SC.3/WP.3/58, paragraphs 4-22),

1. Adopts the text of Recommendations on Harmonized Europe-Wide Technical Requirements for Inland Navigation Vessels annexed to this resolution,
2. Decides to cancel resolution No.17, revised, as well as resolutions Nos. 10, 11, 23, 28, 32, 33, 34, 36, 38, 42, 50, 53, 55 and 56 which are replaced by this resolution,
3. Requests Governments to accept the ship's certificate issued in accordance with the annexed Recommendations as documentary evidence that the vessel complies with the Recommendations on Harmonized Europe-Wide Technical Requirements for Inland Navigation Vessels (as set out in document ECE/TRANS/SC.3/172 as amended) and to take it duly into account when issuing other certificates, if required, for given waterways. In this connection, technical inspection of the vessel may be wholly or partly dispensed with, in so far as regulations in force so permit;

4. Invites Governments to inform the Executive Secretary of the Economic Commission for Europe whether they accept this resolution,

5. Requests the Executive Secretary of the United Nations Economic Commission for Europe to place the question of the application of this resolution periodically on the agenda of the Working Party on Inland Water Transport.

* * *

TABLE OF CONTENTS

| | | Page |
|-------------|---|-------------|
| Chapter 1 | General provisions | 1 |
| Chapter 2 | Procedure and rules for the inspection of inland navigation vessels | 11 |
| Chapter 3 | Shipbuilding requirements | 15 |
| Chapter 3a | Fire protection | 25 |
| Chapter 4 | Safety clearance, freeboard and draught marks | 27 |
| Chapter 5 | Manoeuvrability | 33 |
| Chapter 6 | Steering gear | 35 |
| Chapter 7 | Wheelhouse | 39 |
| Chapter 8 | Engine design | 45 |
| Chapter 8a | Exhaust and pollutant particulate emissions from diesel engines | 53 |
| Chapter 8b | Prevention of water pollution and abatement of noise produced by vessels ... | 57 |
| Chapter 9 | Electrical installations | 61 |
| Chapter 10 | Equipment | 75 |
| Chapter 11 | Working spaces | 87 |
| Chapter 12 | Crew accommodation | 91 |
| Chapter 13 | Fuel-fired heating, cooking and refrigerating equipment (Left void) | 94 |
| Chapter 14 | Liquefied gas installations for domestic purposes | 95 |
| Chapter 15 | Special provisions for passenger vessels | 101 |
| Chapter 15A | Specific requirements for sailing passenger vessels (Left void) | 124 |
| Chapter 16 | Specific requirements applicable to vessels intended to form part of a pushed or towed convoy or of a side-by-side formation | 125 |
| Chapter 17 | Specific requirements applicable to floating equipment (Left void) | 128 |
| Chapter 18 | Specific requirements applicable to worksite craft (Left void) | 128 |
| Chapter 19 | Specific requirements applicable to historic vessels (Left void) | 128 |
| Chapter 19A | Specific requirements applicable to canal barges (Left void) | 128 |
| Chapter 19B | Specific requirements applicable to craft navigating on zone 4 (Left void) | 128 |
| Chapter 20 | Specific requirements applicable to sea-going vessels (Left void) | 128 |
| Chapter 21 | Specific requirements applicable to recreational craft (Left void) | 128 |

TABLE OF CONTENTS

| | Page |
|-------------|--|
| Chapter 22 | Stability of vessels carrying containers..... 129 |
| Chapter 22A | Specific requirements applicable to craft longer than 110 m (Left void) 132 |
| Chapter 22B | Specific requirements applicable to high-speed vessels 133 |
| Chapter 23 | Crews 137 |
| Chapter 24 | Transitional and final provisions (Left void) 148 |
| | |
| Appendix 1 | List of European inland waterways divided geographically into zones 1, 2 and 3..... 149 |
| Appendix 2 | Model ship's certificate..... 161 |
| Appendix 3 | Safety signs and signals to be used on board inland navigation vessels..... 175 |
| Appendix 4 | Alternative manoeuvrability test procedures and criteria in accordance with 5-2.1 177 |
| Appendix 5 | Model of a service record..... 213 |
| Appendix 6 | Criteria for the approval of Classification Societies 229 |

CHAPTER 1 GENERAL PROVISIONS

1-1 PURPOSE AND SCOPE

1-1.1 The purpose of this text is to provide recommendations on the design and equipment of inland navigation vessels with a view, in particular, to promoting the safety of vessels and crews; this text is not a substitute for national laws and regulations.

1-1.2 In general, these Recommendations shall, with due regard to definitions in 1-2, apply to:

- (i) vessels having a length L of 20 meters or more;
- (ii) vessels for which the product of $L \times B \times T$ is a volume of 100 m³ or more.

1-1.3 These Recommendations shall also apply, with due regard to definitions in 1-2, to all:

- (i) tugs and pushers, designated to tow or to push or to move alongside vessels as referred to in 1-1.2;
- (ii) vessels intended for passenger transport which carry more than 12 people in addition to the crew.

1-1.4 In general, these Recommendations shall not apply to:

- (i) ferries;
- (ii) naval vessels.

1-1.5 For the purpose of these Recommendations, European inland waterways shall be classified as follows:

Zone 1 (wave height of up to 2.0 m): the waterways listed in chapter I of appendix 1 to these Recommendations;

Zone 2 (height of up to 1.2 m): the waterways listed in chapter II of appendix 1 to these Recommendations;

Zone 3 (height of up to 0.6 m): the waterways listed in chapter III of appendix 1 to these Recommendations.

On inland waterways not listed in appendix 1 as belonging to navigational zones 1, 2 or 3, Administrations may establish technical requirements which differ from the provisions of these Recommendations. Such technical requirements should be adapted to the geographical, hydrological and navigational conditions prevailing on the respective inland waterway and should be equally applied to all vessels navigating on this waterway. It is understood, however, that vessels allowed to navigate on inland waterways belonging to zones 1, 2 and 3, satisfy the safety requirements applied on those unclassified inland waterways with the exception of the lakes Ladoga and Onega in the Russian Federation.

1-1.6 Unless otherwise stated, the provisions of the present Recommendations shall apply to new vessels that are intended to navigate in the navigational zones mentioned in 1-1.5, differentiated by the maximum significant wave height^{1/} corresponding to a 5 per cent probability of over-topping.

^{1/} In this provision, "significant wave height" means the average of heights of 10 per cent of the total number of waves having the greater heights measured between wave trough and wave crest, observed over a short period.

1-1.7 These provisions shall apply to existing inland navigation vessels so long as the Administration considers them reasonable and practicable.

1-1.8 The Administration may permit derogations from these provisions for limited journeys of local interest or in harbour areas. The derogations in question and the journeys or area for which they are valid shall be specified in the ship's certificate.

1-1.9 Vessels intended for the carriage of dangerous goods shall also satisfy the European Agreement concerning the International Carriage of Dangerous Goods by Inland Waterways (ADN).

1-2 DEFINITIONS

Types of vessels

1. "Vessel": an inland waterway vessel or sea-going ship;
2. "Inland waterway vessel": a vessel intended solely or mainly for navigation on inland waterways;
3. "Tug": a vessel specially built to perform towing operations;
4. "Pusher": a vessel specially built to propel a pushed convoy;
5. "Towed barge": a dumb barge or tank barge built to be towed, either having no motive power of its own or having only sufficient motive power to perform restricted manoeuvres;
6. "Pushed barge": a tank barge or cargo barge built or specially modified to be pushed, either having no motive power of its own or having only sufficient motive power to perform restricted manoeuvres when not part of a pushed convoy;
7. "Ship-borne barge": a pushed barge built to be carried aboard sea-going ships and to navigate on inland waterways;
8. "Passenger vessel": a day-trip or cabin vessel constructed and equipped to carry more than 12 passengers;
9. "Day-trip vessel": a passenger vessel without overnight passenger cabins;
10. "Cabin vessel": a passenger vessel with overnight passenger cabins;
11. "High-speed vessel": a motorized vessel, with the exception of small craft, capable of sailing at a speed greater than 40 km/h in relation to the surface of still water, when this is stated in its ship's certificate;
12. "Floating equipment": a floating structure carrying working gear such as cranes, dredging equipment, pile drivers or elevators;
13. "Ship's boat": a boat used for multipurpose application including transportation of people or cargoes as well as in rescue purposes complying with the requirements of the Basin administration or the European Standard;
14. "Flush-deck vessel": a vessel which has no superstructure on its freeboard deck;

15. “Vessel carrying fixed containers”: vessels all of whose containers are fixed and having the equipment necessary to secure containers to the satisfaction of the Administration;

Assemblies of vessels

16. “Convoy”: a rigid or towed convoy of vessels;

17. “Formation”: the manner in which a convoy is assembled;

18. “Rigid convoy”: a pushed convoy or side-by-side formation;

19. “Pushed convoy”: a rigid assembly of vessels of which at least one is positioned in front of the one or two vessels providing the power for propelling the convoy, known as the “pusher(s)”; a convoy composed of a pusher and a pushed vessel coupled so as to permit guided articulation is also considered as rigid;

20. “Side-by-side formation”: an assembly of vessels coupled rigidly side by side, none of which is positioned in front of the vessel propelling the assembly;

21. “Towed convoy”: an assembly of one or more vessels, floating establishments or assemblies of floating material towed by one or more self-propelled vessels forming part of the convoy;

Particular areas on board

22. “Machinery space”: is the part of the vessel housing the main and auxiliary machinery. The machinery space can be divided up into a main engine room, an engine room and a boiler room;

23. “Main engine room”: the space where the main machinery is installed;

24. “Engine room”: the space where only auxiliary machinery, namely internal combustion engines, is installed;

25. “Boiler room”: the space housing a fuel-operated installation designed to produce steam or to heat a thermal fluid;

26. “Superstructure”: a decked structure on the freeboard deck which extends from side to side of the vessel or whose side walls are not set inboard of the ship’s sides by more than 4% of the breadth (B);

An enclosed superstructure is a superstructure:

having closed bulkheads of sufficient strength, permanently so assembled with the deck as to be watertight;

in which the access openings, if any, in these bulkheads are fitted with watertight doors;

in which all other openings in the sides or ends are fitted with watertight closures;

The height of a superstructure is the mean vertical distance measured at the sides from the top of the freeboard deck beams to the top of the superstructure deck beams;

The length of a superstructure is the mean length of that part of the superstructure which lies within the length (L);

If the superstructure is set in from the ship's plating, the length shall be multiplied by the ratio of the breadth of the superstructure at the middle of its length to the breadth of the ship at the middle of the length of the superstructure;

A forecastle and a poop are superstructures which extend to the forward and the after perpendicular, respectively;

27. "Deckhouse": a decked structure on the freeboard deck or a superstructure deck whose side walls are set inboard of at least one of the ship's sides by more than 4 per cent of the breadth (B);

28. "Wheelhouse": the area which houses all the control and monitoring instruments necessary for manoeuvring the vessel;

29. "Accommodation": a space intended for the use of persons normally living on board, including galleys, storage space for provisions, toilets and washing facilities, laundry facilities, ante-rooms and passageways, but not the wheelhouse;

30. "Passenger area": areas on board intended for passengers and enclosed areas such as lounges, offices, shops, hairdressing salons, drying rooms, laundries, saunas, toilets, washrooms, passageways, connecting passages and stairs not encapsulated by walls;

31. "Control centre": a wheelhouse, an area which contains an emergency electrical power plant or parts thereof or an area with a centre permanently occupied by on-board personnel or crew members, like for fire alarm equipment, remote controls of doors or fire dampers;

32. "Stairwell": the well of an internal staircase or of a lift;

33. "Lounge": a room of an accommodation or a passenger area. On board passenger vessels, galleys are not regarded as lounges;

34. "Galley": a room with a stove or a similar cooking appliance;

35. "Store room": a room for the storage of flammable liquids or a room with an area of over 4 m² for storing supplies;

36. "Hold": part of the vessel, bounded fore and aft by bulkheads, opened or closed by means of hatch covers, intended for the carriage of goods, whether packaged or in bulk, or for housing tanks not forming part of the hull;

37. "Fixed tank": a tank joined to the vessel, the walls of the tank consisting either of the hull itself or of a casing separate from the hull;

38. "Passageway": an area intended for the normal movement of persons and goods;

39. "Safe area": the area which is externally bounded by a vertical surface running at a distance of $1/5 B_{WL}$ parallel to the course of the hull in the line of maximum draught;

40. "Muster areas": areas of the vessel which are specially protected and in which passengers muster in the event of danger;

41. "Evacuation areas": part of muster areas of the vessel from which evacuation of persons can be carried out;

Marine engineering terms

42. “Main machinery”: is that designed to drive the propelling mechanisms and/or serving the main purpose of the vessel;
43. “Auxiliary machinery”: is that which contributes to the operation of the main machinery and that which supplies the vessel with all forms of power necessary for the operation of the vessel’s various systems and installations;
44. “Draught (T)”: the vertical distance in m between the lowest point of the hull or the keel and the plane of maximum draught;
45. “Plane of maximum draught”: the water plane corresponding to the maximum draught at which the vessel is authorized to navigate;
46. “Safety clearance”: the vertical distance measured between the plane of maximum draught and the lowest point above which, disregarding water intakes and outlets, the vessel can not be deemed watertight;
47. “Residual safety clearance”: the vertical clearance available, in the event of the vessel heeling over, between the water level and the lowest point of the immersed side, beyond which the vessel is no longer regarded as watertight;
48. “Moulded depth (D)”: the vertical distance measured from the top of the horizontal keel to the top of the freeboard deck beam amidships at the vessel's side;
49. “Freeboard”: is the vertical distance measured amidships between the upper edge of the deck line as defined in paragraph 4-4.1.1 and the maximum draught level;
50. “Residual freeboard”: the vertical clearance available, in the event of the vessel heeling over, between the water level and the upper surface of the deck at the lowest point of the immersed side or, if there is no deck, the lowest point of the upper surface of the fixed ship's side;
51. “Freeboard deck”: the deck from which the freeboard is measured shall normally be the uppermost complete deck exposed to the weather, up to which the watertight bulkheads of the hull extend and below which all openings in the ship’s sides are fitted with permanent watertight closures;
- In vessels having a discontinuous freeboard deck, the lowest part of the exposed deck and the continuation of that deck parallel to the upper part of the deck shall be taken as the freeboard deck;
52. “Margin line”: an imaginary line drawn on the side plating not less than 10 cm below the bulkhead deck and not less than 10 cm below the lowest non-watertight point of the ship's side. If there is no bulkhead deck, a line drawn not less than 10 cm below the lowest line up to which the outer plating is watertight shall be used;
53. “Water displacement (∇)”: the immersed volume of the vessel in m^3 ;
54. “Displacement (Δ)”: the total weight of the vessel, inclusive of cargo, in t;

55. “Block coefficient (C_B)”: the ratio between the water displacement and the product of length L_{WL} , breadth B_{WL} and draught T ;
56. “Lateral plane above water (A_W)”: lateral plane of the vessel above the waterline in m²;
57. “Bulkhead deck”: the deck to which the required watertight bulkheads are taken and from which the freeboard is measured;
58. “Bulkhead”: a wall of a given height, usually vertical, partitioning the vessel and bounded by the bottom of the vessel, the plating or other bulkheads;
59. “Transverse bulkhead”: a bulkhead extending from one side of the vessel to the other;
60. “Wall”: a dividing surface, usually vertical;
61. “Partition wall”: a non-watertight wall;
62. “Length (L)”: the maximum length of the hull in m, excluding rudder and bowsprit;
63. “Length of waterline (L_{WL})”: the length of the hull in m, measured at the maximum draught;
64. “Breadth (B)”: the maximum breadth of the hull in m, measured to the outer edge of the shell plating (excluding paddle wheels, rub rails, and similar);
65. “Breadth overall (B_{OA})”: the maximum breadth of the vessel in m, including all fixed equipment such as paddle wheels, rub rails, mechanical devices and the like;
66. “Breadth of waterline (B_{WL})”: breadth of the hull in m, measured from the outside of the side plating at the maximum draught line;
67. “Height (H)”: the shortest vertical distance in m between the lowest point of the hull or the keel and the lowest point of the deck on the side of the vessel;
68. “Forward perpendicular”: the vertical line at the forward point of the intersection of the hull with the maximum draught line;
69. “Clear width of side deck”: the distance between the vertical line passing through the most prominent part of the hatch coaming on the side deck side and the vertical line passing through the inside edge of the slip guard (guard-rail, foot rail) on the outer side of the side deck;
70. “Liquid cargo”: all liquids carried on the vessel, including: cargo, stores, ballast, etc.;
71. “Stores”: cargo consumed in the operation of the vessel (fuel, lubricating oil, fresh water, provisions, etc.);
72. “Empty vessel”: a vessel that is fully prepared and equipped with machinery and systems, but with no cargo, passengers, liquid ballast or stores;
73. “Critical angle (φ_{fl})”: angle of heel at which water begins to fill the vessel through unsecured openings, but not exceeding the angle at which the edge of the freeboard deck is submerged, or at which the middle of the bilge leaves the water;

74. “Capsizing angle (φ_c)”: angle of heel at which the vessel begins to capsize under the effect of the heeling moment;
75. “Permissible angle (φ_{perm})”: angle of heel which should not be exceeded and which should be prescribed by the competent authority for the type of vessel under consideration. In general it corresponds to the critical angle φ_{fl} , but should not be greater than the capsizing angle φ_c ;
76. “Amidships”: is at the middle of the length (L);

Steering system

77. “Steering gear”: all the equipment necessary for steering the vessel, such as to ensure the manoeuvrability laid down in chapter 5;
78. “Rudder”: the rudder or rudders, with shaft, including the rudder quadrant and the components connecting with the steering apparatus;
79. “Steering apparatus”: the part of the steering gear which produces the movement of the rudder;
80. “Drive unit”: the steering-apparatus control, between the power source and the steering apparatus;
81. “Power source”: the power supply to the steering control and the steering apparatus produced by an on-board network, batteries or an internal combustion engine;
82. “Steering control”: the component parts of and circuitry for the operation of a power-drive unit;
83. “Steering apparatus control unit”: the control for the steering apparatus, its drive unit and its power source;
84. “Manual drive”: a system whereby manual operation of the hand wheel, moves the rudder by means of a mechanical or hydraulic transmission, without any additional power source;
85. “Manually-operated hydraulic drive”: a manual control actuating a hydraulic transmission;
86. “Rate-of-turn regulator”: equipment which automatically produces and maintains a given rate of turn of the vessel in accordance with preselected values;
87. “Radar equipment”: means electronic assistance to navigation intended for the detection and representation of the environment and traffic;
88. “Inland ECDIS”: means a standardized Electronic Chart Display and Information System for inland navigation, displaying selected information from an Inland System Electronic Navigational Chart drawn up by the manufacturer and, optionally, information from other vessel sensors;
89. “Inland ECDIS equipment”: means equipment intended for the display of inland electronic navigational charts in the following two operational modes: Information Mode and Navigation Mode;

90. “Information Mode”: means the use of the Inland ECDIS for information purposes only without overlaid radar image;

91. “Navigation Mode”: means the use of the Inland ECDIS for conning the vessel with overlaid radar image;

Electrical equipment and automation

92. “Earthing”: means electrical connection to the mass of the hull;

93. “Hull return”: the distribution of direct or alternating current is said to be of the “hull return” type when the insulated conductors are connected to one of the feed poles and the hull or superstructure is connected to the other pole;

94. “Safe voltage”: means a voltage presenting no danger to persons. This condition shall be deemed to be satisfied if the windings of transformers, converters and other voltage-reducing devices are electrically separate and the reduced voltage of such devices or the voltage of sources of electric power does not exceed 50 V between the poles in the case of direct current, or between phases in the case of alternating current;

95. “Automated power installation”: is an installation equipped with automatic control, monitoring and protection of the main and auxiliary machinery and related systems interconnected by remote signalling devices;

96. “Automation system”: is the complex of automation elements, appliances and connections intended for performing prescribed functions in the field of control and monitoring;

97. “Automated remote control system”: is an automation system that provides control and monitoring of the operation of the vessel’s machinery from a remote control station by means of single manipulating of the control element (e.g. handle) by the operator and performs automatically all intermediate operations on preparation for putting into operation, switching on, changing operation modes, reversal, blocking and switching off the main and auxiliary machinery and its systems;

98. “Remote control system”: is an automation system that provides control and monitoring of the operation of an individual vessel’s machinery from a remote control station by means of manipulating the control element by the operator for performing all operations including intermediate ones;

99. “Alarm system”: is an automation system that provides actuating visual and acoustic signals when the controlled parameters reach the limit values or deviations from normal working ranges of the power installation occur;

100. “Safety system”: is an automation system that provides a certain automatic influence on the controlled installation in order to prevent its failure;

101. “Element of an automation system”: is electric, electronic or other device being the part of the automation system (sensor, relay, amplifier, chip, logic element, etc.);

102. “Indicator system”: is one that provides the operator with current information on the monitored physical parameters of the installation (mechanism, system) and changes in these parameters, and is capable of being incorporated into the overall system of automation;

Properties of structural components and materials

103. “Sprayproof”: a device shall be deemed sprayproof if, under all weather conditions encountered in the assigned zone, it allows only a small quantity of water to enter the vessel;
104. “Watertight”: a structural component or device fitted out in such a manner as to prevent any ingress of water;
105. “Gastight”: a structural component or device so fitted as to prevent the ingress of gas and vapours;
106. “Non-combustible”: a substance which neither burns nor produces flammable vapours in such quantities that they ignite spontaneously when heated to approximately 750°C;
107. “Flame-retardant”: material which does not readily catch fire, or whose surface at least restricts the spread of flames pursuant to the procedure referred to in section 15-11.1;
108. “Fire-resistance”: the property of structural components or devices as certified by test procedures according to section 15-11.1;

Other definitions

109. “Oil-containing water”: mixture of water and any quantity of oil formed in the course of operation of a vessel, except for cargo waste;
110. “Domestic waste water”: waste water from galleys, messes, bathrooms (showers and wash basins) or laundries, and human waste water;
111. “Vessel operation refuse”: waste formed in the course of operation of the vessel except for cargo waste;
112. “Household refuse”: organic and inorganic household waste (e.g. remains of food, paper, glass and similar kitchen waste) which does not contain vessel operation refuse;
113. “Collective life-saving appliances”: lifeboats, liferafts, ship’s boats and life-saving buoyancy aids intended for rescue of passengers and the ship’s crew;
114. “Lifeboat”: a boat intended for rescue of people in distress complying with the requirements of the Basin administration, a recognized Classification Society or the International Life-Saving Appliance Code (LSA) of IMO;
115. “Liferaft”: a raft intended for rescue of people in distress, keeping them out of the water complying with the requirements of the Basin administration, a recognized Classification Society or the International Life-Saving Appliance Code (LSA) of IMO;
116. “Life-saving buoyancy aids”: means intended for supporting several persons overboard on the water surface;
117. “Individual life-saving appliances”: means intended for supporting a person overboard on the water surface. They include lifejackets and lifebuoys;
118. “Ship’s certificate”: a certificate in accordance with the model of appendix 2 signifying the compliance of the vessel with the technical provisions of these Recommendations;

119. “Recognized Classification Society”: a Classification Society which has been approved in accordance with the criteria in appendix 6 or which has been recognized by the Administration in accordance with the procedure, conditions and criteria laid down in chapter 1.15 of the regulations annexed to the ADN Agreement;

120. “Administration”: the Administration of the country in which the vessel is registered, or which issues the ship’s certificate;

121. “Basin administration”: the national or international organization that is competent to decide regulations on waterways within a geographical area;

122. “New vessel”: a vessel the keel of which is laid, or which is at a comparable stage of construction, on or after the date of entry into force of these Recommendations decided by the Administration;

123. “Existing vessel”: a vessel in the possession of a valid ship’s certificate or another permission to navigate on the day before the entry into force of these Recommendations decided by the Administration;

124. “Shipboard personnel”: all employees on board a passenger vessel who are not members of the crew;

125. “Persons with reduced mobility”: persons facing particular problems when using public transport, such as the elderly and the handicapped and persons with sensory disabilities, persons in wheelchairs, pregnant women and persons accompanying young children;

CHAPTER 2

PROCEDURE AND RULES FOR THE INSPECTION OF INLAND NAVIGATION VESSELS

2-1 OPERATING ABILITY

2-1.1 Vessels shall be suitable for operation.

2-1.2 Vessels shall be deemed as suitable for operation if they carry a valid ship's certificate certifying compliance with the provisions of these Recommendations concerning construction, installations and equipment of vessels with due regard of 1-1.7.

2-1.3 The ship's certificate shall be issued by the Administration or by a competent authority duly authorized to this purpose by the Administration.

2-2 PURPOSE OF THE INSPECTION

2-2.1 The inspection shall:

2-2.1.1 ensure that the vessel is in all respects satisfactory and suitable for operation in the zone(s) specified in the ship's certificate with due regard to the intended service and possible restrictions relating to the operation of the vessel;

2-2.1.2 ensure the maintenance of conditions mentioned in paragraph 2-2.1.1 above for vessels already holding a ship's certificate;

2-2.1.3 ensure that the markings required for the identification of the vessel are in place such as draught marks and registration number.

2-3 KINDS OF INSPECTION

2-3.1 Vessels shall be subjected to the inspections specified below:

2-3.1.1 An inspection before the issuance of a ship's certificate to a vessel for the first time (initial inspection);

2-3.1.2 A periodical inspection carried out at regular intervals after the certification;

2-3.1.3 A special inspection carried out after major repairs or refitting of the structure which have the effect of altering the main technical characteristics of the vessel, and also in case of change of the mode or area of operation of the vessel or designation of new restrictions relating to the operation of the vessel;

2-3.1.4 on the order of the competent authority, if it is suspected that the vessel is no longer suitable for operation (inspection ex officio).

2-4 PERIODIC INSPECTION

2-4.1 For the renewal of the ship's certificate a periodic inspection shall be carried out on a request by the owner of the vessel in good time before the expiry of its period of validity.

2-4.2 The ship's certificate shall be renewed only if the periodic inspection has ensured that the vessel is suitable for operation as stipulated in paragraph 2-1.2 above.

2-5 COMPETENT AUTHORITY ON THE INSPECTION OF VESSELS

2-5.1 The inspection of vessels intended for use on inland waterways is carried out by the competent authority on the inspection of vessels or qualified bodies, duly authorized by the Administration.

2-6 ADDITIONAL REQUIREMENTS IN THE COURSE OF THE INSPECTION

2-6.1 The competent authority may demand:

2-6.1.1 an inspection out of the water;

2-6.1.2 trial-trips;

2-6.1.3 a mathematical proof of the strength of the hull;

2-6.1.4 a proof of stability and of other vessel's characteristics, for example an inclining experiment, if it is necessary for the inspection of the suitability for operation.

2-6.2 The competent authority may refrain from an inspection in respect of the matters regulated by these Recommendations concerning the construction, installations and equipment of vessels in so far as an attestation of a recognized Classification Society or of an appointed inland vessels surveyor is available. The attestation shall not be older than six months.

2-7 OFFICIAL NUMBER

2-7. 1 The competent authority issuing a certificate shall enter on that certificate the official number assigned to that vessel by the competent authority of the State in which the vessel has been registered or has its home port.

2- 7.2 The official number shall consist of eight Arabic numerals, as follows:

The first two or three digits shall indicate the country and place where the official number was assigned. For this purpose the following key shall apply:

| | |
|------------------|-----------|
| - Austria | 220 - 239 |
| - Belgium | 060 - 069 |
| - Bulgaria | 89 |
| - Croatia | 96 |
| - Czech Republic | 95 |
| - Denmark | 100 - 119 |
| - Finland | 120 - 139 |
| - France | 001 - 019 |
| - Germany | 040 - 059 |
| - Greece | 140 - 159 |
| - Hungary | 86 |
| - Ireland | 160 - 179 |
| - Italy | 180 - 199 |
| - Luxembourg | 200 - 219 |
| - Netherlands | 020 - 39 |
| - Poland | 83 |
| - Portugal | 240 - 259 |

| | |
|---------------------------------------|-----------|
| - Republic of Moldova | 98 |
| - Romania | 88 |
| - Russian Federation | 92 |
| - Serbia | 97 |
| - Slovakia | 94 |
| - Spain | 280 - 299 |
| - Sweden | 260 - 279 |
| - Switzerland | 070 - 079 |
| - Ukraine | 93 |
| - United Kingdom and Northern Ireland | 300 - 319 |
| - United States of America (USA) | 91 |
| - Other States | 99 |

The next five or six digits of the official number shall indicate the serial number in the register kept by the competent authority.

2-7.3 The official number shall remain invariable throughout the existence of the vessel. However, if that vessel is registered in another State or if its home port is transferred there, the official number shall no longer be valid. The ship's certificate shall then be submitted to a competent authority on the inspection of vessels which shall delete the official number that has ceased to be valid and, if necessary, shall enter the new official number.

CHAPTER 3

SHIPBUILDING REQUIREMENTS

3-1 STRENGTH

3-1.1 The general structural strength of the hull shall be sufficient to withstand all stresses under normal conditions of operations.

3-1.2 The structure of the hull, superstructures, deckhouses, machinery casings, companionways, hatchways and their closures, etc., and the equipment shall be designed to withstand the normal conditions of operation to the satisfaction of the Administration. The Administration may consider this requirement met by a vessel built and maintained in conformity with the rules of a recognized Classification Society.

However the minimum thickness for bottom and side plating shall never be less than 3 mm.

3-2 STRUCTURAL REQUIREMENTS

3-2.1 Openings in decks

All removable covers shall be protected against accidental shifting. Access openings shall be such as not to interfere with safe movement without prejudice to the requirements of other safety regulations and, in particular, those of chapter 4, the coamings shall be as low as possible. There shall be no possibility of covers and doors closing accidentally.

3-2.2 Hatchways

3-2.2.1 Construction of hatchways

Cargo hatchways shall be surrounded on all sides by coamings. It shall be made impossible for loading tackle to catch on the lower edges of hold coamings.

3-3 STABILITY

3-3.1 General requirements

3-3.1.1 A vessel shall be designed and constructed to provide sufficient intact stability for all anticipated service conditions.

3-3.1.2 A sufficient margin of stability shall be allowed for every stage of the voyage, taking into account any increase in weight such as might result from the absorption of water by the cargo or from icing, if the vessel is to operate under conditions where increases of this kind may occur.

3-3.1.3 The Administration may exempt a vessel from all stability checks provided that basic stability data are available for a sister vessel and it is shown to the Administration's satisfaction that all the stability information for that vessel can be validly used.

3-3.1.4 The Administration may consider the stability of the vessel as sufficient, if a stability information has been approved by a recognized Classification Society.

3-3.2 Special requirements for vessels navigating in zone 1

3-3.2.1 Proof of sufficient stability shall be provided by calculation. In cases where the Administration does not apply requirements of its own, a vessel may be considered as having sufficient stability when it satisfies the criteria given in this chapter. Every vessel referred to in paragraph 3-3.2.3 shall, on completion, undergo an inclining test in the presence of an expert of the Administration to determine the displacement of the light vessel and the coordinates of its centre of gravity.

3-3.2.2 In the calculations mentioned in paragraph 3-3.2.1, the adverse effects which the carriage of certain bulk cargoes may have on stability shall be taken into account.

3-3.2.3 All new vessels and all vessels which have undergone conversions that may affect their stability shall be furnished with approved information on their stability.

3-3.2.4 In the case of certain cargo vessels known to be stable, the stability information may be based on calculations only, and an inclining test may be dispensed with.

3-3.2.5 The stability information referred to in paragraph 3-3.2.3 shall comprise:

The stability characteristics for typical loading conditions;

Information in the form of tables or diagrams which will enable the boatmaster to assess the stability of his vessel and verify whether it is sufficient in other loading conditions.

3-3.3 Special requirements for vessels navigating in zones 2 and 3

Vessels shall have sufficient stability. In cases where the Administration does not apply stricter requirements of its own, a vessel may be considered as having sufficient stability when it satisfies the criteria given in this chapter.

3-4 SUBDIVISION

3-4.1 Watertight bulkheads

3-4.1.1 Watertight bulkheads carried up to the uppermost continuous deck shall be fitted in the places mentioned below.

3-4.1.2 A collision bulkhead shall be fitted at an appropriate distance from the forward perpendicular. If the vessel has a long forecastle, the Administration may require the collision bulkhead to be carried up to the forecastle deck.

3-4.1.3 In vessels navigating in zones 2 and 3 the collision bulkhead shall be between $0.04 L$ and $0.04 L + 2$ m. In vessels navigating in zone 1, the collision bulkhead shall be between $0.04 L$ and $0.08 L$ aft of the forward perpendicular, where L is the length defined in paragraph 1-2.

3-4.1.4 In vessels more than 25 m long, a bulkhead shall be fitted in the after part of the vessel at an appropriate distance from the after perpendicular having regard to the configuration of the vessel's after extremity.

3-4.1.5 The accommodation, engine rooms and boilers, and the working spaces forming part of these, shall be separated from the holds by watertight transverse bulkheads that extend up to the deck.

3-4.1.6 The Administration may require watertight bulkheads other than those mentioned above in regard to the vessel's design.

3-4.1.7 The Administration may permit derogations from these provisions, provided that equal safety is assured.

3-4.1.8 The bulkheads, the doors and closures in the bulkheads and the methods used for testing them shall comply with the requirements of the Administration or of a recognized Classification Society.

3-4.2 Openings in watertight bulkheads

3-4.2.1 General requirements applicable to all zones

3-4.2.1.1 No door or manhole shall be permitted in the collision bulkhead.

3-4.2.1.2 The number and dimensions of the openings in other watertight bulkheads shall be reduced to the minimum compatible with the design and operation of the vessel; satisfactory devices shall be provided for the watertight closing of these openings, with indicators showing whether the devices are open or closed. It shall be possible to open and close doors on the spot from either side of the bulkhead.

3-4.2.1.3 Where shafts, pipes, scuppers, electric cables, etc., are carried through watertight subdivisions, arrangements shall be made to avoid impairing the watertight integrity of the bulkheads or decks.

3-4.2.1.4 In the collision bulkhead, no valves or cocks shall be fitted which open directly into the compartments lying abaft that bulkhead.

Such devices shall be avoided so far as possible in the other watertight bulkheads; if, however, such devices are fitted, they shall at all times be capable of being opened and closed from an accessible point situated above the uppermost continuous deck. Indicators shall be fitted to show whether the devices are open or closed.

3-4.2.1.5 If the drainage pipes of the forepeak tank pass through the collision bulkhead, each pipe shall be fitted with a valve which is controlled from a point situated above the freeboard deck and which is fitted to the collision bulkhead inside the forepeak.

3-4.2.2 Special requirements for vessels navigating in zone 1

Doors in watertight bulkheads shall be provided with a system for watertight closing, workable from either side of the bulkhead in proximity to the door and from a point above the maximum draught level. Each door shall be fitted with indicators which show, at all operating stations, whether it is open or closed.

In the accommodation and working spaces, however, and in the tweendeck immediately below the freeboard deck, remote control shall not be required. The doors shall be capable of being opened or closed on the spot from either side of the bulkhead. Hinged doors may be allowed.

3-5 CRITERIA FOR CHECKING THE STABILITY OF VESSELS**3-5.1 General principles**

3-5.1.1 The stability criteria do not take into account any shifting of cargo.

3-5.1.2 A vessel shall be deemed sufficiently stable if, for the loading conditions considered in 3-5.1.6, it satisfies:

- (i) The requirement that the initial metacentric height, corrected for the free-surface effects of liquid cargo, should have a positive value;
- (ii) Weather criteria, as determined in accordance with the requirements of section 3-5.2 below;
- (iii) The requirements for stability, as determined in accordance with the requirements of section 3-5.3 below with respect to the type and purpose of the vessel.

3-5.1.3 The values for the moments of the external forces exerted on the vessel shall be taken as constant for the whole range of inclination of the vessel.

3-5.1.4 The permissible heeling moment for all required loading conditions shall be determined by means of a static or a dynamic stability curve in accordance with the values of permissible angle of heel given for the various stability criteria in sections 3-5.2 and 3-5.3 below.

For vertical-sided vessels, the maximum permissible heeling moments may be determined without constructing a curve, on the basis of the following formulae:

- (i) For the dynamic effect of the external forces:

$$M_{perm} = 0.0856 \cdot \Delta \cdot \overline{GM}_0 \cdot \varphi_{perm} \quad (kNm)$$

- (ii) For the static effect of the external forces:

$$M_{perm} = 0.1712 \cdot \Delta \cdot \overline{GM}_0 \cdot \varphi_{perm} \quad (kNm).$$

where: \overline{GM}_0 = initial metacentric height corrected for the free-surface effects of liquid cargo, in metres;

M_{perm} = permissible heeling moment.

3-5.1.5 The free-surface effects of liquid cargo shall be taken into account in the calculation of stability.

For liquid cargo in tanks where the quantity of liquid changes during the operation of the vessel, the calculation shall be made with the tanks filled to 50% of their capacity.

A tank filled with liquid cargo to more than 95% of its capacity shall be deemed completely full.

In calculating the stability of a vessel, the liquid cargo residues commonly found up to a depth of 5 cm in evacuated tanks shall not be taken into account.

If the vessel is intended for the transport of various types of liquid cargo, the calculation shall assume the most unfavourable loading condition.

3-5.1.6 The stability of vessels, other than passenger vessels, should be checked for the following most unfavourable loading conditions:

- (i) With 10% stores, with no cargo;
- (ii) With 100% stores and 100% cargo.

If the vessel carries solid ballast, its mass shall be included as part of the light weight.

For all loading conditions, the inclusion of liquid ballast as part of the load should be agreed with the Administration.

3-5.2 Weather criteria

3-5.2.1 The vessel shall satisfy the weather criterion if, under the most unfavourable loading condition, the permissible moment produced by dynamic inclinations of the vessel is equal to or greater than the heeling moment resulting from the dynamic pressure of the wind, i.e. if the following condition is met:

$$M_{perm} \geq M_{wd}$$

where: M_{perm} = permissible moment produced by the dynamic inclinations of the vessel corresponding to the critical angle or to the capsizing angle, if the latter is smaller;

M_{wd} = heeling moment resulting from the dynamic pressure of wind, as in 3-5.2.3.

3-5.2.2 Certain types or individual vessels need not be checked for stability with respect to the weather criterion if the competent authorities are satisfied beyond doubt that the stability requirements are met by the said vessels in any case.

3-5.2.3 The heeling moment resulting from the dynamic pressure of the wind shall be taken as:

$$M_{wd} = 0.001 \cdot P_{wd} \cdot A_w \cdot l_w \quad (kNm)$$

where: P_{wd} = specific wind pressure, whose value shall be taken from the following table for the navigation zone of the vessel and for the lever arm;

l_w = lever arm of free-floating vessel = distance between the centre of gravity of the lateral area and the plane of the load waterline considered, when the vessel is upright in calm water (m).

Specific wind pressure P_{wd} (Pa):

| l_w (m) Navigation zone | 1 | 2 | 3 | 4 | 5 | 6 |
|------------------------------|-----|-----|-----|-----|-----|-----|
| 2 | 232 | 279 | 318 | 345 | 369 | 388 |
| 3 | 178 | 217 | 247 | 269 | 286 | 302 |

The lateral plane above water A_w should include all above-water projected surfaces (hull, superstructure, deck machinery, deck cargo, and other elements of the above-water part of the vessel) at the centre of the vessel when it is upright. The projected areas of structures of round section located separately on the deck should be assumed to have an effective coefficient of flow of 0.6.

The lateral area of lattice-type structures above the waterline shall be calculated on the basis of the areas bounded by these structures multiplied by the coefficients of fullness taken from the following table:

| Type of lattice structure | Coefficient of fullness |
|---------------------------|-------------------------|
| Life rails | |
| without guard mesh | 0.2 |
| with guard mesh | 0.6 |
| Other lattice structures | 0.3 – 0.5 |

3-5.3 Stability requirements for different types of ships

3-5.3.1 Passenger vessels shall comply with the requirements of section 15-3.

3-5.3.2 Cargo vessels

3-5.3.2.1 The stability of cargo vessels carrying deck cargo or cargo in holds, where the centre of gravity of the lateral area of the vessel and cargo is more than 2 m above the load waterline considered, should satisfy the supplementary requirement laid down in 3-5.3.2.2.

3-5.3.2.2 The heeling moment of a vessel resulting from the static effect of wind M_{wst} should not exceed the maximum permissible moment produced by the static inclinations of the vessel M_{perm} , i.e., the following condition should be met:

$$M_{perm} \geq M_{wst}$$

where: M_{perm} = maximum permissible moment produced by the static inclinations of the vessel = moment corresponding to an angle of heel representing 80% of the critical angle;

M_{wst} = as in 15-3.5.

3-5.3.2.3 All vessels for which the ratio of the total power of the main machinery N_e to the maximum permissible displacement Δ is $N_e/\Delta > 0.75$ kW/t shall be checked with respect to the turning criterion as in 15-3.6. Their angle of heel should not in this case exceed 80 per cent of the critical angle.

3-5.3.3 Tugs

3-5.3.3.1 Tug vessels shall have sufficient stability if the maximum permissible moment of the vessel M_{perm} (see 3-5.2.1) is greater than or equal to the sum of the heeling moments resulting from the dynamic effect of wind M_{wd} (see 3-5.2.3) and the dynamic effect of the lateral component of the bollard pull force M_t (see 3-5.3.3.2), i.e., if the following condition is met:

$$M_{perm} \geq M_{wd} + M_t$$

3-5.3.3.2 The heeling moment resulting from the dynamic pressure of the lateral component of the bollard pull force shall be determined by the formula:

$$M_t = 1.1 \cdot T_B \cdot (z_t - T)$$

where: z_t = height of the point of application of the bollard pull force above the base line (m);
 T_B = maximum bollard pull force measured on checking at moorings (kN).

In cases where T_B is not known, the following values shall be assumed for calculation purposes:

For $\Delta \leq 30 t$:

$T_B = 0.13 N_e$ - for tugs without propeller nozzles;

$T_B = 0.20 N_e$ - for tugs with propeller nozzles;

For $\Delta \geq 30 t$:

$T_B = 0.16 N_e$ - for tugs without propeller nozzles;

$T_B = 0.20 N_e$ - for tugs with propeller nozzles:

where N_e = the total power of the main machinery (kW).

3-5.3.3.3 In addition to the conditions laid down in 3-5.3.3.1, the stability of each tug should satisfy the following supplementary requirement:

The angle of heel resulting from the combined effect of the heeling moments produced by the dynamic pressure of wind M_{wd} and the effect of the centrifugal force on turning M_{cf} (see 15-3.6) should not exceed the critical angle and should in no case exceed 15°.

3-5.4 Supplementary requirements for vessels in navigation zone 1

3-5.4.1 General provisions

3-5.4.1.1 The stability of vessels intended for navigation in zone 1 should satisfy the requirements of sections 3-5.1, 3-5.2 and 3-5.3 for vessels of zone 2, and also the supplementary requirements of this section. Furthermore, the conditions for satisfactory stability laid down in paragraph 3-5.1.2, subparagraphs (i) and (ii) should also be met for the simultaneous rolling of the vessel.

3-5.4.1.2 Compliance with the applicable requirements of the IMO Recommendations for sea-going vessels may be considered as equivalent to compliance with these Recommendations.

3-5.4.1.3 When checking stability with respect to the weather criterion, the heeling moment resulting from the dynamic pressure of wind M_{wd} shall be calculated taking the specific wind pressure P_{wd} for navigation zone 2, as in the table at paragraph 3-5.2.3.

3-5.4.1.4 The permissible heeling moment M_{perm} shall be determined by means of the stability curve, taking into account the value for the amplitude of roll calculated as in 3-5.4.2.

3-5.4.1.5 The critical angle shall be taken to be the angle of heel at which water begins to fill the vessel through unsecured openings in the side plating or on the deck. The maximum angle

may not extend further than the upper edge of the side coaming of the cargo hatch or the upper edge of the expansion trunks of tankers.

3-5.4.2 Calculation of the value for the amplitude of roll of a vessel

3-5.4.2.1 The value for the amplitude of roll φ_m of a flat-bottomed vessel with a bilge radius of $0.05 B$ or more not fitted with bilge keels shall be determined from the following table in terms of a value m calculated by the formula:

$$m = 0.66 \cdot m_1 \cdot m_2 \text{ (s}^{-1}\text{)}$$

where m_1 and m_2 = factors determined in accordance with paragraphs 3-5.4.2.2 and 3-5.4.2.3.

| | | | | | | | |
|-------------------------------------|------|------|------|------|------|------|--------------|
| $m \text{ (s}^{-1}\text{)}$ | 0.40 | 0.60 | 0.80 | 1.00 | 1.20 | 1.40 | 1.60 or more |
| $\varphi_m \text{ (}^\circ\text{)}$ | 9 | 10 | 13 | 17 | 20 | 23 | 24 |

3-5.4.2.2 The factor m_1 shall be calculated by the formula:

$$m_1 = \frac{m_0}{\sqrt{\overline{GM}}} \text{ (s}^{-1}\text{)}$$

where: \overline{GM} = initial metacentric height for the loading condition considered, without correction for the free-surface effects of liquid cargo;

m_0 = a value from the following table in relation to the parameter n_1 determined by the formula: $n_1 = \frac{B \cdot \overline{GM}}{KG \cdot \sqrt[3]{\Delta}}$

where: KG = see paragraph 15-3.6.

| | | | | | | | | | | |
|-------|-------------|------|------|------|------|------|------|------|------|-------------|
| n_1 | 0.1 or less | 0.15 | 0.25 | 0.50 | 0.75 | 1.00 | 1.50 | 2.00 | 2.50 | 3.0 or more |
| m_0 | 0.42 | 0.52 | 0.78 | 1.38 | 1.94 | 2.40 | 3.00 | 3.00 | 3.50 | 3.60 |

3-5.4.2.3 The non-dimensional factor m_2 shall be taken from the following table as a function of the ratio B/T .

| | | | | | | | | | | |
|-------|-------------|-----|------|------|------|------|------|------|------|------------|
| B/T | 2.5 or less | 3.0 | 3.5 | 4.0 | 5.0 | 6.0 | 7.0 | 8.0 | 9.0 | 10 or more |
| m_2 | 1.0 | 0.9 | 0.81 | 0.78 | 0.81 | 0.87 | 0.92 | 0.96 | 0.99 | 1.0 |

3-5.4.2.4 In cases where the bilge radius is less than $0.05 B$, the value for the amplitude of roll determined in accordance with paragraph 3-5.4.2.1 may be reduced to a value of φ determined

by the formula:
$$\varphi = \varphi_m \cdot \left(0.75 + \frac{5r}{B}\right) \text{ (degrees)}$$

where: r = bilge radius (m).

3-5.4.2.5 The amplitude of roll φ_m determined in accordance with paragraph 3-5.4.2.1 shall be taken into account in the stability curve (see sketches 3-5.4.2.5.1(a) and (b) and 3-5.4.2.5.2(a) and (b)).

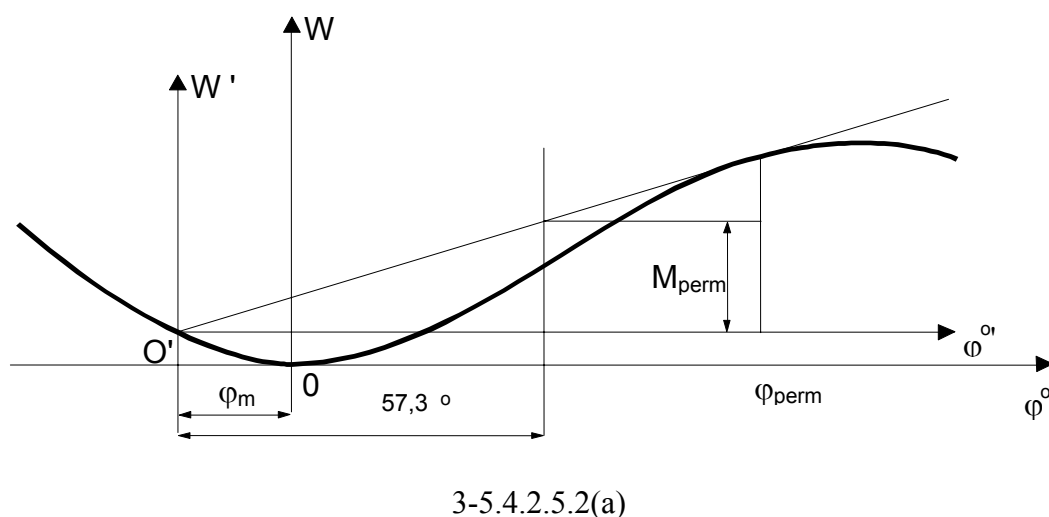
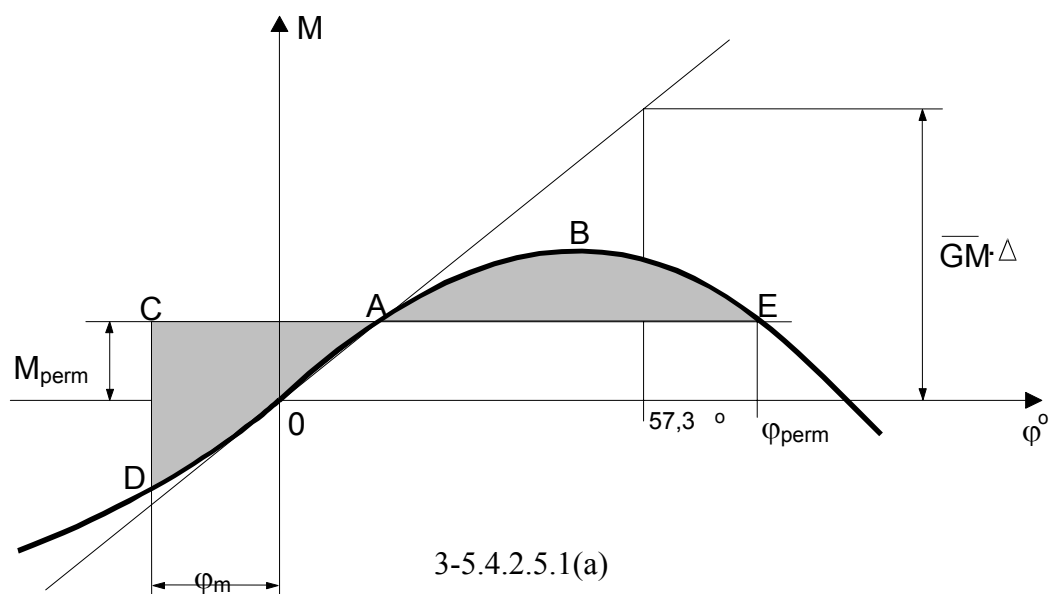

Explanation of sketches 3-5.4.2.5.1 (a) and (b) and 3-5.4.2.5.2 (a) and (b)

Sketches 3-5.4.2.5.1(a) and 3-5.4.2.5.1(b) show static stability curves constructed taking into account the amplitude of roll φ_m in the following manner:

The curves are amplified by a static stability curve in the area of negative angles of heel to the abscissa φ_m (segment O-D);

In order to determine the maximum heeling moment, the area on the static stability diagram below the curve up to angle φ_{perm} (ABE) should be equal to the area above the curve (ACD);

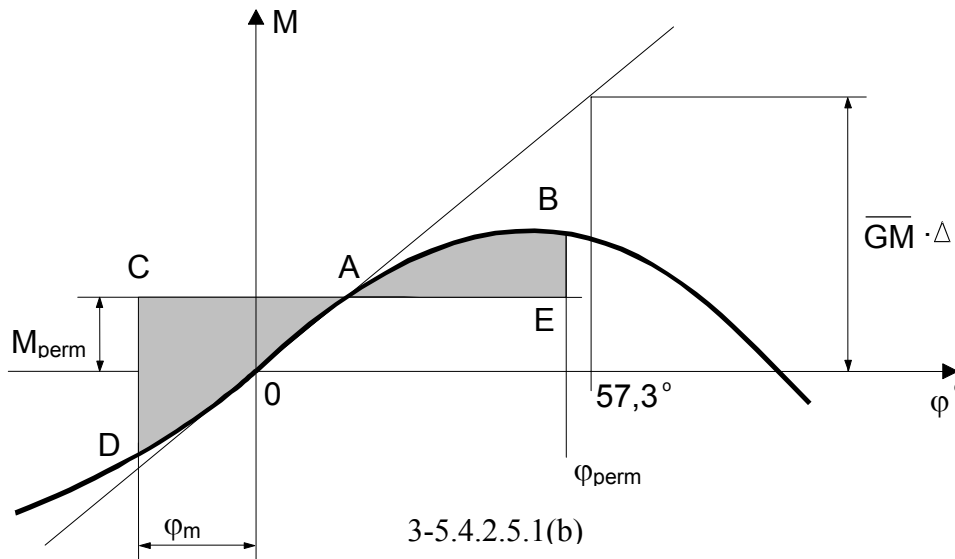

The diagram in sketch 3-5.4.2.5.1(a) shows a case in which the angle φ_{perm} equals the capsizing angle, and the diagram in sketch 3-5.4.2.5.1(b) a case in which the angle φ_{perm} equals the angle of maximum heel which is permissible on other grounds.

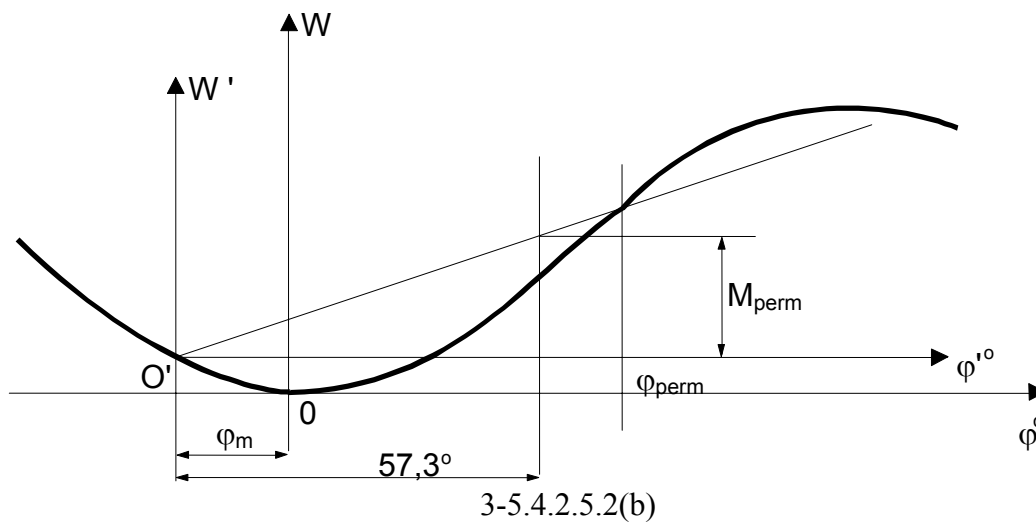

Sketches 3-5.4.2.5.2(a) and 3-5.4.2.5.2(b) show static stability curves constructed taking into account the amplitude of roll φ_m in the following manner:

The curves are amplified by a dynamic stability curve in the area of negative angles of heel to the abscissa φ_m ;

A tangent to the dynamic stability curve is produced through new origin O' in order to determine the maximum capsizing moment φ_{perm} (cf. sketch 3-5.4.2.5.2(a)), or a straight line is produced through the point of intersection of the dynamic stability curve with a vertical straight line drawn from the point of the angle of heel φ_{perm} which is permissible on other grounds;

The segment at an angle of 1 radian gives the value of the maximum permissible heeling moment.

CHAPTER 3A FIRE PROTECTION

3A-1 STRUCTURAL REQUIREMENTS

3A-1.1 The hull, superstructures, structural bulkheads, decks and deckhouses shall be made of steel. The Administration or a recognized Classification Society may allow the use of other materials with due regard to the risk of fire.

On vessels with a length of 85 m or more and intended for navigation in zone 1, in accommodation spaces, the corridor bulkheads shall be made of steel or other materials approved by the Administration or recognized Classification Society with due regard to the risk of fire.

3A-1.2 Crew elevator trunks within accommodation and interior stairways below the open deck shall be made of steel or equivalent material.

3A-1.3 The bulkheads of galleys, paint stores, lamprooms, boatswain's stores (when adjacent to accommodation spaces) and emergency generator rooms, if any, shall be made of steel or equivalent material.

3A-1.4 Deck, bulkhead and ceiling coverings within accommodation spaces shall be made of flame-retardant materials. They shall be made of fire resistant materials when they form part of an escape route or a partition between the accommodation space and machinery spaces or store rooms. The furniture in the above-mentioned accommodation spaces shall be made of a material which will not easily catch fire. In the case of fire or heating the materials shall not release toxic or explosive gases in dangerous concentrations.

3A-1.5 Bulkheads, ceilings and doors of machinery spaces and boiler rooms shall be made of steel or other equally fire-resistant material.

Stairways and ladders leading to machinery spaces and boiler rooms shall be fixed permanently and made of steel or equivalent material.

3A-1.6 Paints, varnishes and similar products having a nitro-cellulose or other highly inflammable base shall not be used for the interior furnishings in a vessel's spaces.

3A-1.7 Tanks and their pipelines as well as other accessories shall be laid out and arranged with due regard to the risk of fire and in such a way that no fuel or gas can escape accidentally into the vessel. Tank valves intended for fuel sampling or water drainage shall close automatically. Materials with a low resistance to heat shall not be used for overboard scuppers, sanitary discharges or other outlets which are close to the water line, or in places where failure of the material in the event of fire might cause flooding.

3A-1.8 At tank outlets the pipelines for the distribution of liquid fuels shall be fitted with a shutoff device that can be operated from the deck.

3A-1.9 Electric radiators shall be so designed and fixed in position as to reduce fire risks to a minimum.

3A-1.10 Forced ventilation of machinery spaces shall be capable of being stopped from an easily accessible position outside the machinery spaces.

3A-1.11 Automatic devices for detecting and signalling about smoke or heat, which indicate fire on board, shall satisfy the requirements of the Administration or recognized Classification Society.

3A-2 MEANS OF ESCAPE

3A-2.1 In all crew spaces and spaces in which crew members are normally employed, stairways and ladders shall be so installed as to provide a ready means of escape to an open deck.

3A-2.2 Living and sleeping quarters shall have at least two exits as far apart from each other as possible which serve as escape routes. One of them may be designed as an emergency exit. This does not apply to areas with an exit giving directly onto the deck or into a corridor which serves as an escape route, provided the corridor has two exits at a distance from each other and giving onto port and starboard. Emergency exits, which may include skylights and windows, shall have a clear opening of at least 0.36 m² with a smallest side of at least 0.50 m and permit rapid evacuation in an emergency.

3A-2.3 Engine and boiler rooms shall have two exits of which one may be an emergency exit.

The second exit may be dispensed with if:

- (i) the total floor area (average length x average width) of the engine or boiler room does not exceed 35 m²; and
- (ii) the distance between each point where service or maintenance operations are to be carried out and the exit, or foot of the stairway near the exit providing access to the outside, is not longer than 5 m; and
- (iii) a fire extinguisher is placed at the maintenance station that is furthest removed from the exit door.

3A-3 STORAGE OF FLAMMABLE LIQUIDS

To store flammable liquids with a flash point of less than 55°C there shall be a ventilated cupboard made of non-combustible material on deck. On its outside there shall be a symbol "No naked lights or fires and no smoking" in accordance with sketch 2 of appendix 3 and with a diameter of at least 10 cm.

CHAPTER 4

SAFETY CLEARANCE, FREEBOARD AND DRAUGHT MARKS

4-1 GENERAL

4-1.1 This chapter specifies the minimum freeboard for inland waterway vessels. It also contains requirements concerning the indication of the freeboard mark.

4-1.2 This chapter assumes that the nature and stowage of the cargo, ballast, etc., are such as to ensure adequate stability and as to obviate any excessive structural fatigue.

4-1.3 Freeboards as prescribed in this chapter shall be assigned on the assumption, first, that navigation will cease when weather conditions are such that the maximum wave height defining the zone or zones in which a vessel is to navigate may be exceeded, and second that in such conditions vessels already under way will seek shelter as quickly as possible.

4-1.4 The Administration may consider it sufficient if the vessel has been built and maintained in conformity with the rules of a recognized Classification Society.

4-2 TYPES OF VESSELS

For the purpose of this chapter, vessels shall be divided into three types:

Type A - Decked vessels

Type B - Tankers

Type C - Open vessels

Type A: Decked vessels. Decked vessels are vessels whose hatch covers are satisfactorily strong, rigid, watertight for zone 1 and sprayproof for zones 2 and 3.

Type B: Tankers and similar vessels. These vessels have only small openings giving access to the tanks, the openings being closed by steel or equivalent covers with watertight fittings. Such vessels have the following characteristics:

- (i) Very high watertight integrity of the exposed deck;
- (ii) Very high resistance to flooding, through low permeability of the loaded compartments and through the degree of subdivision applied in general.

Type C: Open vessels. Open vessels are either vessels whose hatch covers are not satisfactorily strong, rigid, sprayproof or vessels whose cargo hatchways are open.

4-3 APPLICATION AND DEROGATIONS

4-3.1 The maximum draught level shall be so determined that both the freeboard requirements and the safety-distance requirements are observed. For safety reasons, however, the Administration may prescribe a higher figure for the freeboard.

4-3.2 Vessels so constructed that application of the provisions of this chapter is unwarranted or impracticable shall be assigned freeboards by the Administration in such a way that the safety conditions are equivalent to those of this chapter.

4-3.3 In the case of zone 1, derogations from the conditions of assignment of freeboard

may be allowed to vessels to which a freeboard in excess of the minimum freeboard is assigned, provided that the safety conditions are deemed satisfactory by the Administration.

4-4 DETERMINATION OF FREEBOARDS

4-4.1 General

4-4.1.1 Deck line

The deck line is the upper edge of a horizontal rectangle 300 mm long and 25 mm wide. This rectangle shall be marked amidships on each side of the hull, and its upper edge shall normally pass through the point where the continuation outwards of the upper surface of the freeboard deck intersects the outer surface of the shell amidships. However, the deck line may also be marked at a different height provided that the freeboard is corrected accordingly.

4-4.1.2 Freeboard mark

The freeboard mark for vessels for zone 3 consists of a horizontal band of 300 mm long and 40 mm width.

The freeboard mark for zones 1 and 2 shall consist of a ring intersected through its centre by a horizontal line which shall be supplemented if necessary by additional freeboard lines.

The width of the ring and of all the other lines of the freeboard mark shall be 30 mm; the outer diameter of the ring shall be 200 mm; the length of the horizontal line intersecting the ring shall be 300 mm; and the size of the numerals designating the zones shall be 60 x 40 mm (Figure 1).

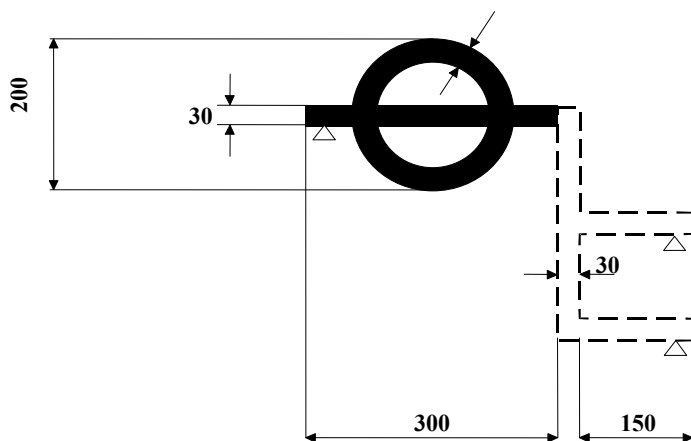
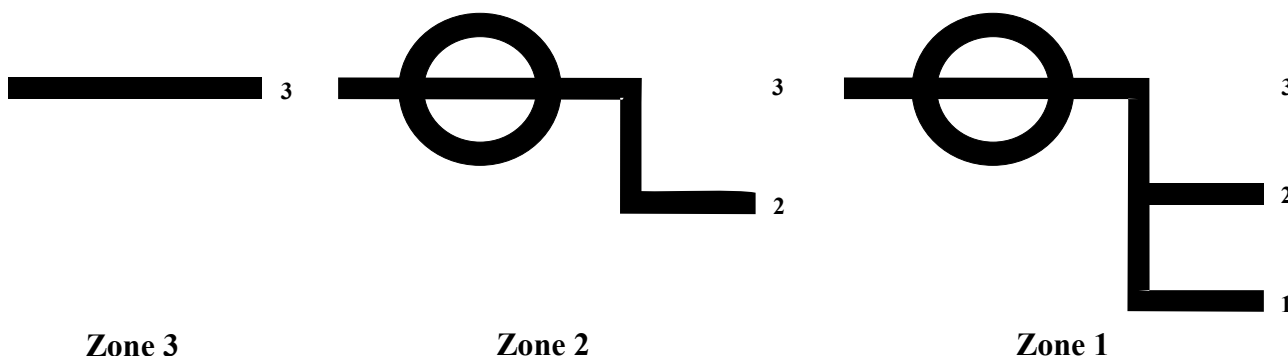

Figure 1

Zones 1 and 2



Zone 3

Zone 2

Zone 1

The centre of the ring shall be placed amidships. The lower edge of the horizontal line which intersects the ring shall pass through the centre of the ring and shall constitute the freeboard line.

If the vessel is intended to navigate in several navigation zones, a vertical line and additional freeboard lines 150 mm in length shall be applied forward of the centre of the ring.

The lower edge of each freeboard line shall correspond to the freeboard prescribed for the navigation zone concerned.

If the vessel is measured in accordance with the Convention on the Measurement of Inland Navigation Vessels, it shall bear, in addition to the freeboard mark, a measurement mark in accordance with the requirements of this Convention. The freeboard mark and the measurement mark may be combined. In this case, the width of the freeboard mark rectangle (the width of the upper line if there are a number of freeboard marks) should be 40 mm.

4-4.2 Minimum freeboard in zones 1 and 2

4-4.2.1 Minimum freeboard (F) for vessels of type A

| Length of the vessel m | Minimum freeboard (F) mm | |
|------------------------|--------------------------|--------|
| | Zone 1 | Zone 2 |
| ≤ 30 | 250 | 250 |
| 40 | 340 | 300 |
| 50 | 440 | 340 |
| 60 | 570 | 340 |
| 70 | 570 | 340 |
| ≥ 80 | 570 | 340 |

Note: In this and all subsequent tables, the values for the intermediate lengths of vessels shall be obtained by linear interpolation.

4-4.2.2 Minimum freeboard (F) for vessels of type B

| Length of the vessel m | Minimum freeboard (F) mm | |
|------------------------|--------------------------|--------|
| | Zone 1 | Zone 2 |
| ≤ 30 | 180 | 160 |
| 40 | 250 | 220 |
| 50 | 330 | 220 |
| 60 | 420 | 220 |
| 70 | 420 | 220 |
| ≥ 80 | 420 | 220 |

4-4.2.3 The minimum freeboard of flush-deck vessels should be obtained in the manner indicated for the vessel of type B.

4-4.2.4 The minimum freeboard for vessels of type C, regardless of length, should be not less than:

for zone 1 - 1000 mm
zone 2 - 600 mm.

Furthermore, the sum of the freeboard and the height of coamings for these vessels must be not less than:

- for zone 1 - 1200 mm
- zone 2 - 1000 mm.

4-4.2.5 The Administration may authorize corrections for the freeboard for vessels with poop, sheer and forecastle, providing that such corrections are calculated in conformity with the rules of the Administration or of a recognized Classification Society.

4-4.3 Arrangement of openings and coamings

4-4.3.1 All outside doors of superstructure, deckhouses and companionways, situated on the freeboard deck shall be watertight on vessels in zone 1 and sprayproof on vessels in zones 2 and 3.

4-4.3.2 The coamings of hatchways, companionways and access openings to superstructures shall be not less than 300 mm high on vessels in zone 1 and 150 mm on vessels in zone 2.

4-4.3.3 If the height of the coamings is less than that required by this chapter, the minimum freeboard height shall be increased by the difference between the height required in 4-4.3.2 and the actual height of the coamings.

4-4.3.4 The freeboard height may not be reduced owing to an increase in the height of coamings below the figure indicated in 4-4.3.2.

4-4.3.5 Exposed cargo hatchways and other hatchways on the freeboard deck shall be fitted with watertight closures on vessels in zone 1 and sprayproof closures on vessels in zones 2 and 3.

4-4.3.6 Ventilator heads on the exposed parts of the freeboard deck shall be fitted with a strong steel coaming of a height not less than that required for hatchway coamings. Ventilator heads for vessels in zone 1 must have watertight closures.

4-4.3.7 Pipe outlets in the ship's sides below the freeboard deck shall be fitted with efficient and accessible devices to prevent water from entering the vessel.

4-4.3.8 On vessels in zone 1, side scuttles in spaces below the freeboard deck, windows in superstructures, deckhouses and companionways and windows in skylights on the freeboard deck shall be watertight. In addition, side scuttles in spaces below the freeboard deck shall be provided with permanently attached deadlights. The distance between side scuttles in the shell and the maximum draught level shall not be less than 300 mm.

4-4.3.9 Skylights and windows must be of sturdy construction

4-4.3.10 On vessels in zones 2, skylights and windows must be fitted with sprayproof covers which shall be permanently attached if the lowest part of the openings falls within the safety clearance prescribed for the coamings of uncovered holds (para. 4-4.3.11). In this case, the height (h) of the superstructures in which the openings are provided is limited to the lowest point of these openings.

4-4.3.11 For vessels of type A and type B, the safety clearance as defined in paragraph 4-4.1.1 must not be less than 600 mm for zone 2.

For vessels of type C, as well as other vessels navigating with open holds, this distance shall be increased to 400 mm in zone 2. However, this increase applies only to the coamings of open holds.

4-4.3.12 The covers of Kingston valves and ice boxes must be watertight.

4-4.3.13 The scuppers and freeing ports in bulwarks shall be of sufficient size to drain the decks of shipped water.

4-4.4 Special requirements for freeboard in zone 3.

4-4.4.1 For vessels of types A and B, the safety clearance must not be less than 300 mm.

4-4.4.2 For vessels of the type C, the safety clearance must not be less than 500 mm.

4-4.4.3 The basic freeboard of vessels with a continuous deck without superstructures and sheer shall be 150 mm.

4-4.4.4 The Administration may authorize a correction for the freeboard for vessels with superstructures and sheer providing that such correction is calculated in conformity with the rules of the Administration or of a recognized Classification Society.

In view of the reduction referred to above the minimum freeboard shall not be less than 0 mm.

CHAPTER 5 MANOEUVRABILITY

5-1 GENERAL

- 5-1.1 Vessels and convoys shall display adequate navigability and manoeuvrability.
- 5-1.2 Powered vessels and convoys shall meet the requirements set out in appendix 4.

5-2 NAVIGATION TESTS

5-2.1 Navigability and manoeuvrability shall be checked by means of navigation tests. The following, in particular, shall be examined in accordance with the requirements of one of the alternatives as set out in appendix 4:

speed (forward);
stopping capacity;
capacity for going astern;
capacity for changing course;
turning capacity.

5-2.2 The competent authority on the inspection of vessels; shall enter into the ship's certificate under number 52, which of the alternatives as set out in appendix 4 has been applied for the navigation tests.

5-2.3 The Basin administration may dispense with all or part of the tests where compliance with the navigability and manoeuvrability requirements is proven in another manner.

5-3 TEST AREA

5-3.1 The navigation tests referred to in paragraph 5-2 shall be carried out on areas of inland waterways that have been designated by a competent authority.

5-3.2 Those test areas shall be situated on a stretch of running or still water that is if possible straight, at least 2 km long and sufficiently wide and is equipped with highly-distinctive marks for determining the position of the vessel.

5-3.3 It shall be possible for the competent authority on the inspection of vessels to plot the hydrological data such as depth of water, width of navigable channel and average speed of the current in the test area as a function of the water level.

5-4 LOADING OF VESSELS AND CONVOYS DURING NAVIGATION TESTS

During navigation tests, vessels and convoys intended to carry goods shall be loaded in accordance with the requirements of the Basin administration.

5-5 USE OF ON-BOARD FACILITIES FOR NAVIGATION TEST

5-5.1 During the navigation test, all of the equipment providing the manoeuvrability of the vessel which may be actuated from the wheelhouse may be used, apart from any anchor.

5-5.2 However, during the test involving turning into the current referred to in paragraph 5-10, the anchors may be used.

5-6 SPEED (FORWARD)

5-6.1 Vessels and convoys shall achieve at least the required speed in relation to the water according to the requirements of one of the alternatives as set out in appendix 4. In any case, such speed should not be less than 12 km/h.^{2/}

5-6.2 The competent authority on the inspection of vessels may grant exemptions to vessels and convoys operating solely in estuaries and ports.

5-6.3 The competent authority on the inspection of vessels shall check whether the vessel sailing light has the capacity to exceed a speed of 40 km/h relative to the water. If so, the following particular shall be entered in the ship's certificate: "The vessel has the capacity to exceed a speed of 40 km/h relative to the water."

5-7 STOPPING CAPACITY

5-7.1 Vessels and convoys shall be able to stop in good time and within the limits of the minimum required distance while remaining adequately manoeuvrable.

5-7.2 Where vessels and convoys are not longer than 86 m and not wider than 22.9 m, the Basin Administration may replace the stopping capacity mentioned above by turning capacity against the current.

5-8 CAPACITY FOR GOING ASTERN

5-8.1 Vessels and convoys are to have sufficient capacity for going astern, which has to be checked during the tests.

5-8.2 Where the stopping manoeuvre required by paragraph 5-7 is carried out in still water it shall be followed by a test while going astern.

5-9 CAPACITY FOR CHANGING COURSE

Vessels and convoys shall be able to change course in good time. That capacity shall be proven by means of manoeuvres carried out within a test area as referred to in paragraph 5-3.

5-10 TURNING CAPACITY

The turning capacity shall be examined in accordance with the requirements of one of the alternatives as set out in appendix 4.

^{2/} Administration may assign to vessels and convoys operating exclusively within a particular river basin, a minimum speed that differs from the value prescribed in this paragraph, taking into account local conditions and manoeuvrability of the vessels/convoys.

CHAPTER 6 STEERING GEAR

6-1 GENERAL REQUIREMENTS

6-1.1 Vessels shall be equipped with steering gear which ensures at least the manoeuvrability prescribed in chapter 5.

6-1.2 The steering gear shall be so constituted that the rudder position cannot change unexpectedly.

6-1.3 The entire steering gear shall be designed for a permanent list up to 15°, an angle of trim up to 5° and ambient temperatures from - 20°C to + 40°C.

6-1.4 The component parts of the steering gear shall be rugged enough always to be able to withstand the stresses to which they may be subjected during normal operation. No external forces applied to the rudder shall impair the operating capacity of the steering equipment and its controls.

6-1.5 The steering gear shall comprise a power-driven unit if the forces required to activate the rudder require so.

6-1.6 The power-driven unit of the steering gear shall be protected against overload.

6-1.7 The penetrations for the rudder stocks shall be so designed as to prevent the spread of water-polluting lubricants.

6-2 STEERING APPARATUS CONTROL UNIT

6-2.1 If the steering gear has a power-driven unit, in case of the failure or breakdown of the steering apparatus control unit, it shall be possible to bring a second unit or a manual drive into service within five seconds.

6-2.2 If the second steering apparatus control unit or manual drive is not automatically brought into service, it shall be possible for the helmsman to bring it into service simply and rapidly by means of a single manipulation.

6-2.3 The second drive unit or manual drive shall ensure the manoeuvrability prescribed in chapter 5.

6-3 HYDRAULIC DRIVE UNIT

6-3.1 No consumer appliance may be connected to the hydraulic drive unit of the steering gear.

6-3.2 If there are two hydraulic drive units, a hydraulic tank is required for each of them; double tanks, however, are permitted. The hydraulic tanks shall be equipped with an oil low-level indicator with alarm.

6-3.3 The dimensions, construction and arrangement of the piping shall ensure, as far as possible, that they will not be damaged by mechanical effects or fire.

6-3.4 Hoses are only permitted when their use is indispensable to absorb vibrations and permit the freedom of movement of the constituent parts. They shall be rated at least according to the maximum working pressure.

6-4 POWER SOURCE

6-4.1 If the steering gear is equipped with two power-driven units, it shall have two power sources.

6-4.2 If the second power source for the power-driven unit is not permanently available while the vessel is under way, a buffer device is required. Its capacity shall be sufficient to provide power during the period needed for bringing the second power source into operation.

6-4.3 In the case of electrical power sources, no other consumers may be powered by the network supplying the steering gear.

6-5 MANUAL DRIVE

6-5.1 The hand wheel shall not be actuated by the power-driven unit.

6-5.2 Regardless of rudder position hand wheel kickback must be prevented when the manually-operated wheel is engaged automatically.

6-6 RUDDER-PROPELLER, WATER-JET, CYCLOIDAL-PROPELLER, AND ACTIVE BOW-RUDDER SYSTEMS

6-6.1. In the case of rudder-propeller, water-jet, cycloidal-propeller or active bow-rudder installations where the remote control of the modification of the direction of the drive is electric, hydraulic or pneumatic, there shall be two steering apparatus control units independent of each other, between the wheelhouse and the installation, and on analogy, meet the requirements of paragraphs 6-1 to 6-5.

Such systems are not subject to this section, if they are not necessary in order to achieve the manoeuvrability required by chapter 5 or if they are only needed for the stopping test.

6-6.2 Where there are several rudder-propeller, water-jet, cycloidal-propeller or bow-rudder systems that are independent of each other, the second steering apparatus control unit is not necessary if the vessel retains the manoeuvrability required by chapter 5 if one of the units fails.

6-7 INDICATORS AND MONITORING DEVICES

6-7.1 The rudder position shall be clearly displayed at the steering position. If the rudder-position indicator is electrical, it shall have its own power supply.

6-7.2 There shall be at least the following indicators or monitoring devices at the steering position:

- (i) oil level in the hydraulic tanks in accordance with paragraph 6-3.2, and working pressure of the hydraulic system;
- (ii) failure of the electrical supply for the steering control;
- (iii) failure of the electrical supply for the drive unit;

- (iv) failure of the rate-of-turn regulator;
- (v) failure of the required buffer devices.

6-8 RATE-OF-TURN REGULATORS

6-8.1 The rate-of-turn regulators and their components shall meet the requirements laid down in paragraph 9-2.18.

6-8.2 The proper functioning of the rate-of-turn regulator shall be displayed at the steering position by means of a green warning light.

Any lack of or unacceptable variations in the supply voltage and an unacceptable fall in the speed of rotation of the gyroscope shall be monitored.

6-8.3 Where, in addition to the rate-of-turn regulator, there are other steering control systems, it shall be possible to distinguish clearly at the steering position which of these systems has been activated. It shall be possible to shift from one system to another immediately. The rate-of-turn regulator shall not cause any kickback in the steering systems.

6-8.4 The electrical supply to the rate-of-turn regulator shall be independent of that for the other power consumers.

6-8.5 The gyroscopes, detectors and rate-of-turn indicators used in the rate-of-turn regulators shall meet the minimum requirements and test conditions concerning rate-of-turn indicators for inland waterways as set by the competent authority.

6-9 APPROVAL

6-9.1 The compliance of the installed steering system shall be checked by a competent authority on the inspection of vessels. It may, for this purpose, request the following documents:

- (i) description of the steering gear;
- (ii) drawings and information on the steering apparatus control units;
- (iii) information concerning the steering apparatus;
- (iv) electrical wiring diagram;
- (v) description of the rate-of-turn regulator;
- (vi) system-use instructions.

6-9.2 Operation of the entire steering gear shall be checked by means of a navigation test. It shall be checked that a predetermined course can be reliably maintained by the rate-of-turn regulators and that bends can be negotiated safely.

CHAPTER 7 WHEELHOUSE

7-1 GENERAL REQUIREMENTS

7-1.1 It shall be possible to control and monitor propelling machinery and steering gear from the steering station. Propelling machinery fitted with a clutch which can be operated from the steering station or actuating a rudder propeller which can be operated from the steering station may be started and stopped only from the engine room.

7-1.2 Every engine shall be controlled by a single lever moving through the arc of a circle in a vertical plane more or less parallel to the longitudinal axis of the vessel. Forward movement of the lever shall cause the vessel to move forward and movement of the lever towards the stern shall cause the vessel to move astern. Engaging and reversing the engine shall be carried out by the lever. The neutral position of the lever shall be indicated by a perceptibly distinguishable click or by a perceptibly distinguishable marking. The sweep of the lever from the neutral position to the "full speed ahead" position and from the neutral position to the "full speed astern" position shall not exceed 90°.

7-1.3 The wheelhouse shall be equipped with adjustable heating and ventilation systems. The wheelhouse darkening device shall not interfere with ventilation.

7-1.4 The glazing used in wheelhouses shall display a light transmission of at least 75%.

7-1.5 Under normal operating conditions, the sound-pressure level of the noise produced by the vessel shall not exceed 70 dB(A) at the helmsman's head position. However, the Administration may authorize a sound-pressure level of 75 dB(A) at the helmsman's head position for vessels not more than 30 m in length, with the exception of pushers.

7-1.6 Tell-tale lamps or any other equivalent device for monitoring the signal lights shall be installed in the wheelhouse unless that monitoring can be performed direct from the wheelhouse.

7-2 UNOBSTRUCTED VIEW

7-2.1 The view from the steering station shall be sufficiently unobstructed in all directions.

7-2.2 A sufficiently unobstructed view in all directions from the steering station shall be deemed to be provided if the following conditions are met:

- (i) The unobstructed field of view from the helmsman's position shall cover at least 240° of the horizon, including at least 140° in the forward half-circle;
- (ii) No window frames, posts, etc. shall be placed in the helmsman's normal line of vision;
- (iii) The view through the windows in the helmsman's normal line of vision shall be kept clear under all weather conditions (rain, snow, frost) by suitable devices;
- (iv) If, in spite of the field of view of 240° or more, the sufficiently unobstructed view cannot be ensured astern, the competent authority may require other measures to be taken, such as the installation of auxiliary optical devices.

7-2.3 The dead area of vision forward of the bow of the unloaded vessel shall not extend beyond 250 m. The use of optical devices to reduce the dead area shall not be considered for the purposes of this requirement.

7-3 REQUIREMENTS CONCERNING CONTROL, DISPLAY AND MONITORING EQUIPMENT

7-3.1 The controls shall move easily into the operating position, which shall be unmistakably clear.

7-3.2 Monitoring instruments shall be easily readable whatever the lighting conditions inside the wheelhouse. Their illumination shall be capable of continuous adjustment to the point of extinction, so that the illumination is not dazzling and at the same time there is no impairment of visibility.

7-3.3 There shall be a system for testing the warning lights.

7-3.4 It shall be possible to establish clearly whether a system is in operation. If its functioning is indicated by means of a warning light, the latter shall be green.

7-3.5 Any malfunctioning or failure of systems that require monitoring shall be indicated by means of red warning lights.

7-3.6 An audible warning shall sound at the same time that the red warning lights light up. The audible warnings may consist of a single, common signal. The sound pressure level of that signal shall exceed the maximum sound pressure level of the ambient noise at the steering station by at least 3 dB(A).

7-3.7 The audible warning system may be switched off after the malfunction or failure has been confirmed. This shutdown shall not prevent the alarm signal from being triggered by other malfunctions. The red warning lights shall only go out when the malfunction has been corrected.

7-3.8 The monitoring and display devices shall be automatically connected to an alternative power supply if the main power supply fails.

7-3.9 Devices for the remote control of the steering gear as a whole shall be installed permanently and so that the heading selected is clearly visible. If the remote control devices can be disengaged, they shall be fitted with an indicator showing whether the device is "in use" or "not in use". The arrangement and the manipulation of the controls shall be functional. Impermanent remote-control equipment for systems that are subsidiary to the steering system, such as active bow rudders, shall be acceptable provided that such a subsidiary installation can be activated by means of an override at any time within the wheelhouse.

7-4 RADAR EQUIPMENT AND RATE-OF-TURN CONTROL

7-4.1 The radar equipment and rate-of-turn indicators must be of types that have been approved by the competent authorities. The requirements of the competent authority concerning installation and operational monitoring shall be met. Inland ECDIS equipment which may be used in Navigation Mode shall be considered to be radar equipment. The Inland ECDIS equipment shall also meet the requirements of the Inland ECDIS Standard prescribed by resolution No. 48 (TRANS/SC.3/156), as amended.

7-4.2 The radar indicator must be located in such a way as to permit the boatmaster to monitor the situation around the vessel on the indicator and to control the vessel from his post. The distance from the vessel's steering station to the radar indicator shall not exceed 800 mm.

7-4.3 Cordless remote control panels for radar equipment are not permitted.

7-4.4 The radar equipment must have a built-in operational monitoring feature permitting the boatmaster to check variations in operating parameters and to set the instrument correctly when radar targets are unavailable.

7-4.5 The image on the radar indicator must be clearly visible irrespective of the lighting conditions in the wheelhouse. The illumination of the controls and the indicator should not be so intense as to dazzle the boatmaster when he is operating the vessel.

7-4.6 The radar antenna must be installed so as to ensure that there is the best possible coverage on the indicator screen along the vessel's course, with no dead sectors within 5° to port or starboard, and that the coverage of the horizon is, if possible, unobstructed by superstructure, piping or other structures.

7-4.7 The antenna must be installed sufficiently high up to ensure that the high-frequency radiation flux density on open decks where there may be people does not exceed the permitted level.

7-4.8 Onboard radar equipment must be electrically operated from the main and emergency power supplies.

7-4.9 The rate-of-turn indicator must be located ahead of the helmsman and within his field of vision, and as close as possible to the screen of the radar equipment.

7-4.10 Where rate-of-turn regulators are used, it shall be possible to release the rate-of-turn control in any position without any change occurring in the selected rate. The sector through which the control rotates shall be large enough to ensure that it can be positioned with sufficient accuracy. The neutral position shall be perceptibly distinguishable from the other positions. Illumination of the scale shall be continuously adjustable.

7-4.11 Departures from or additions to the requirements listed above shall be permitted on condition that all departures and additions are validated by the establishment of better working conditions for boatmasters or the improvement of the operating and technical specifications of radar equipment.

7-5 ALARM SYSTEM

7-5.1 The helmsman must have within reach an on/off switch controlling the alarm signal; switches which automatically return to the off position when released are not acceptable.

7-5.2 There shall be a general alarm system, as well as an independent alarm system which reaches open decks; accommodation spaces; engine rooms; pump rooms, where appropriate, and other service premises.

7-5.3 The sound pressure level for the alarm signal shall be at least 75 dB(A) within the accommodation area. In the engine rooms and pump rooms the alarm signal shall take the form of a flashing light that is visible on all sides and clearly perceptible at all points.

7-6 SPECIAL WHEELHOUSE ARRANGEMENTS FOR RADAR STEERING BY ONE PERSON

7-6.1 General provision

A wheelhouse shall be deemed to be specially arranged for radar steering, by one person, if it meets the requirements of this section.

7-6.2 General requirements relating to design

7-6.2.1 The wheelhouse shall be designed in such a way that the helmsman shall be able to accomplish his task while seated.

7-6.2.2 All appliances, instruments and controls shall be so arranged that the helmsman can use them conveniently during the voyage without leaving his seat and without losing sight of the radar screen.

7-6.2.3 The radar display shall be placed in the wheelhouse forward of the helmsman's position in such a way that the helmsman can observe the image on the screen with no significant change in his line of vision. The radar image shall continue to be perfectly visible, without a mask or screen, whatever the lighting conditions applying outside the wheelhouse. The rate-of-turn indicator shall be installed directly above or below the radar screen or be incorporated within.

7-6.3 Signalling equipment

7-6.3.1 Signal lights shall be controlled from a light-control switchboard on which the tell-tale lamps shall be arranged in position corresponding to the actual positions of the signal lights. Failure of a signal light shall cause the corresponding tell-tale lamp to go out or to be signalled in another manner by the corresponding warning light.

7-6.3.2 It shall be easy to operate the acoustic warning signals while performing steering operations.

7-6.4 Installations for manoeuvring the vessel and controlling the propelling machinery

7-6.4.1 The vessel's steering gear shall be controlled by one lever, which can be easily manipulated manually. Every movement of the steering device shall be accompanied by an exact indication of the position of the rudders. The neutral position shall be perceptibly indicated. The rudders shall remain in position in the absence of further actuations of the steering device.

7-6.4.2 If the vessel is also fitted with reversing rudders or bow rudders, they shall be controlled by separate devices meeting the above requirements. This requirement shall also apply to convoys where the steering gear of vessels other than the vessels propelling the convoy is used.

7-6.4.3 The direction of the propulsion thrust imparted to the vessel and the rotational speed of propellers or main machinery shall be displayed.

7-6.4.4 An emergency stopping device for the main machinery shall be provided and shall function independently of the remote control system.

7-6.5 Installations for anchor manoeuvres

The helmsman shall be able, without leaving his seat, to drop anchors which are necessary for an emergency stop of his vessel.

7-6.6 Communication equipment

7-6.6.1 Vessels shall be fitted with a radiotelephone installation for ship-to-ship and ship-to-shore communication. Reception shall be by loudspeaker and transmission by fixed microphone. Reception/transmission shall be selected by a push-button.

7-6.6.2 The connection to the public communication system, if available, shall be independent of the installation referred to in paragraph 7-6.6.1.

7-6.6.3 There shall be a voice intercommunication network on board. It shall enable the helmsman to communicate at least with the bow of the vessel or the head of the convoy, the boatmaster's cabin, the crew accommodation and the stern of the vessel or convoy if no other means of direct communication from the wheelhouse is possible. The voice intercommunication network shall be so installed that the helmsman can easily use it while carrying out the steering operations. At all sound-link locations, reception shall be by loudspeaker and transmission by fixed microphone. The link with the bow and stern of the vessel or head and stern of the convoy may be by radio-telephone.

7-6.7 Entry in the ship's certificate

Where a vessel complies with the requirements of this chapter in respect of wheelhouses that have been designed for radar navigation by one person, the following statement shall be entered in the ship's certificate:

“The vessel has special wheelhouse arrangements for steering on radar by one person”.

7-7 MOVABLE WHEELHOUSES

7-7.1 General requirements

7-7.1.1 Movable wheelhouses should be fitted with an emergency lowering system. All lowering operations should automatically trigger an audible warning signal. This requirement shall not apply, if the risk of corporal injury which may result from lowering, is prevented by appropriate design features.

It must be possible to leave the wheelhouse safely, whatever its position.

7-7.1.2 A vertically movable wheelhouse and its gear shall be designed in such a way as not to adversely affect the safety of persons on board.

7-7.1.3 Hoisting and lowering shall not interfere with operations performed from the wheelhouse.

7-7.2 Requirements relating to construction

7-7.2.1 The hoisting mechanism shall be designed to hoist at least 1.5 times the weight of the wheelhouse fully equipped and fully manned.

7-7.2.2 The mechanism for hoisting the wheelhouse shall function reliably and without jamming under all possible conditions of asymmetrical load, as well as at all angles of ship's list and trim, which could occur during its normal operation.

7-7.2.3 The wheelhouse shall be earthed.

7-7.2.4 The feed cables for systems inside the wheelhouse shall be laid and fastened, in such a way, as to exclude the possibility of mechanical damage to them.

7-7.2.5 The device for fastening the cables may also be used for laying hoses or pipes leading into the wheelhouse. The distance between such hoses or pipes and the cables shall be not less than 100 mm.

7-7.2.6 Optical signalling of the following positions shall be provided:

- (i) Electric drive switchboard live;
- (ii) Wheelhouse in lower terminal position;
- (iii) Wheelhouse in upper terminal position.

7-7.3 Requirements relating to the hoisting gear drive

7-7.3.1 The gear for hoisting and lowering the wheelhouse shall have a power drive capable of functioning under all conditions of the ship's operation.

7-7.3.2 Emergency lowering of the wheelhouse shall be effected under its own weight and shall be smooth and controllable.

7-7.3.3 The hoisting mechanism shall enable the wheelhouse to stop and remain in any position.

On board vessels intended for zones 1 and 2, the Basin administrations may require that it shall be possible to fix the wheelhouse in different positions. A possibility for immediate release of the fixing arrangements should be ensured under all operational conditions, inclusive of a total power failure.

7-7.3.4 Automatic cutting out of the hoisting mechanism in the terminal positions shall be provided.

7-7.3.5 Lowering of the wheelhouse shall be effected by one person under all conditions. Emergency lowering control shall be possible from both inside the wheelhouse and a control station outside. The speed of emergency lowering of the wheelhouse shall be not less than the speed of lowering effected by means of the main drive.

7-7.3.6 The use of a self-braking hoisting mechanism shall not be permitted.

CHAPTER 8 ENGINE DESIGN

8-1 MACHINERY

8-1.1 General

8-1.1.1 Machinery and their attachments shall be designed, built and installed in accordance with the state of the art, the rules of the Administration and/or of a recognized Classification Society. It shall be possible to start and stop the machinery, and if necessary to reverse the main machinery, reliably, quickly and safely.

The main machinery and auxiliary machinery, boilers and pressure vessels, together with their accessories shall be fitted with safety devices.

8-1.1.2 The liquid fuel for the main or auxiliary machinery shall have a flashpoint above 55°C. In certain cases, such as for lifeboat engines, the Administration may allow a fuel with a flashpoint below 55°C.

8-1.1.3 Installations requiring special inspections, such as boilers and pressure vessels, shall comply with the rules of the Administration or with the rules of a recognized Classification Society.

8-1.1.4 The fuel system, the lubricating and cooling-water systems and the starting devices shall conform to the requirements of the Administration or to the rules of a recognized Classification Society.

8-1.1.5 The following parameters of the main machinery shall be monitored by means of suitable devices, which trigger an alarm once a critical level has been reached:

- (i) The temperature of the cooling water;
- (ii) The lubricating oil pressure for the engines and transmissions;
- (iii) The oil and air pressure of the reversing units, reversible transmissions or propellers.

8-1.1.6 Where vessels have only one main propulsion engine, that engine shall not be shut down automatically except in order to protect against over-speed of the engine.

8-1.2 Main machinery/shafting

8-1.2.1 The main machinery power shall make the vessel sufficiently manoeuvrable under normal operating conditions.

8-1.2.2 The control devices shall be so constructed that they cannot be accidentally moved from their appointed position.

8-1.2.3 A reliable and effective system of two-way communication shall be provided between the main machinery space and the wheelhouse.

8-1.2.4 Where the main machinery is remote-controlled, a local control station shall be provided.

8-1.2.5 It shall be possible to turn the main machinery over in complete safety.

8-1.2.6 If the propeller shafts cannot be disconnected, they shall be equipped with suitable blocking devices.

8-1.2.7 Shafting shall be designed in such a way as to prevent the spread of water-polluting lubricants.

8-1.3 Machinery space

8-1.3.1 In the machinery space the machinery, accessories and equipment shall be so placed as to be readily accessible and safe for operation, dismantling and maintenance.

8-1.3.2 All moving parts of the machinery and transmissions dangerous to members of the crew shall be fitted with appropriate protective devices.

8-1.3.3 The machinery and equipment shall be installed on sturdy and rigid seatings firmly fixed to the vessel's hull.

8-1.3.4 The machinery space shall be provided with efficient ventilation.

8-1.3.5 The floor plates of the machinery space shall be fixed and made of sufficiently firm non-slip sheet metal. They have to be removable.

8-1.3.6 All doors and hatch covers usable as exits from the machinery space shall open and close from both inside and outside. The covers of skylights not intended for use as exits shall be closable from outside.

8-1.4 Gas exhaust system

8-1.4.1 All exhaust gases shall be evacuated outside the vessel. All necessary steps shall be taken to prevent dangerous gases from penetrating the various compartments.

8-1.4.2 Exhaust pipes shall be suitably shielded, insulated or cooled. Protection against physical contact may suffice outside the engine rooms.

8-1.4.3 Gas exhaust pipes, which pass through accommodation or the wheelhouse shall, in those compartments, be enclosed within a gastight protective sleeve. The space between the exhaust pipe and the sleeve shall communicate with the open air.

8-1.4.4 The exhaust pipes shall be arranged and protected in such a way that they cannot cause a fire. If the exhaust pipes run alongside or pass through inflammable materials, those materials shall be effectively protected.

8-1.5 Fuel system

8-1.5.1 Liquid fuels shall be stored in steel tanks or, if so required by the design of the vessel, in an equivalent material in terms of fireproofing, this forming part of the hull or being firmly attached to this. That requirement shall not apply to tanks having a capacity of no more than 12 litres that have been incorporated in ancillaries at the factory. No tank for any liquid fuel shall be installed forward of the collision bulkhead.

8-1.5.2 Fuel tanks shall not be situated near sources of heat. Daily-service tanks, their fittings and connections shall not be located above engines or gas exhaust pipes. Drip-trays shall be placed under daily-service tanks.

8-1.5.3 Fuel transfer pumps, fuel separators and oil burners, shall be fitted with a local control device and a stopping device situated in an easily accessible position outside the spaces where they are installed.

8-1.5.4 Fuel pipes shall be independent of other piping systems.

8-1.5.5 Fuel may be heated only by devices allowed by the Administration.

8-1.5.6 Fuel tanks, their piping and other accessories shall be so designed and installed that no fuel or gas can escape into the vessel. Tank valves intended for fuel sampling or water drainage shall be of a self-closing type.

8-1.5.7 Fuel shall be supplied by means of a leak-proof connection.

8-1.5.8 If machinery can run on either light or heavy fuel, measures shall be taken to avoid mixing different kinds of fuel by accident.

8-1.5.9 At tank outlets the pipeline for the distribution of liquid fuels shall be fitted with a shutoff device that can be operated from the deck. That requirement shall not apply to tanks mounted directly on the engine. Fuel pipes, their connections, seals and fittings shall be made of materials that are able to withstand the mechanical, chemical and thermal stresses to which they are likely to be subjected. The fuel pipes shall not be subjected to any damaging effects of heat and it must be possible to monitor them throughout their length.

8-1.5.10 Pipes for filling liquid-fuel tanks, other than daily supply tanks, shall have their opening above the deck and shall be fitted with a cap. Every such tank shall be fitted with a vent pipe leading to the open air above the deck and so placed that no water can enter it. Its cross-section shall be at least 1.25 times the cross section of the filler neck. The filler openings for fuel tanks shall be marked distinctly.

8-1.5.11 Fuel- and lubricating oil tanks shall be provided with a capacity-gauging device that is legible right up to the maximum filling level. External gauge columns shall be effectively protected against impacts, shall be fitted with self closing valves at their base and shall be attached at their upper part to the tanks above their maximum filling level. The material used for the gauge columns shall not deform under normal ambient temperatures.

8-1.5.12 Tanks which directly supply essential machinery shall be equipped with a device that gives a visual and acoustic signal in the wheelhouse when their degree of filling is no longer sufficient for reliable operation.

8-1.5.13 Tanks for liquid fuel or lubricating oil shall not have vertical common walls with accommodation spaces. Fuel tanks shall not have common surfaces with drinking water tanks.

8-1.5.14 Liquid fuel tanks shall be provided with openings having leak-proof closures that are intended to permit cleaning and inspection.

8-1.5.15 Fire hazards which might result from the splashing of liquid fuel or other inflammable liquids on to hot surfaces shall sufficiently be prevented by:

- (i) Suitable construction, arrangement or shielding of the high pressure pipes carrying such liquids;
- (ii) Heat-resistant insulation of hot surfaces by oil proof or sheet-metal shielding.

8-1.6 Bilge pumping systems

8-1.6.1 It shall be possible to pump each watertight compartment dry separately. However, that requirement shall not apply to compartments that are normally sealed hermetically during operation.

8-1.6.2 Vessels requiring a crew shall be equipped with two separate bilge pumps which shall not be installed within the same space. At least one of these shall be motor driven. However, if the power units for such vessels develop less than 225 kW or with deadweight of less than 350 t, respectively, or where vessels not intended for the carriage of goods have a displacement of less than 250 m³, one manually operated or motor-driven pump will suffice. Each of the required pumps shall be capable of use on each watertight compartment.

8-1.6.3 The pumping capacity of the first bilge pump shall be calculated by the formula:

$$Q_1 = 0.1 \cdot d_1^2 \text{ [l/min]}$$

d_1 is calculated by the formula

$$d_1 = 1.5 \sqrt{L(B+H)} + 25 \text{ [mm]}.$$

The pumping capacity of the second bilge pump shall be calculated, by the following formula:

$$Q_2 = 0.1 \cdot d_2^2 \text{ [l/min]}$$

d_2 is calculated by the formula:

$$d_2 = 2 \sqrt{l(B+H)} + 25 \text{ [mm]}.$$

However, the value d_2 may be taken not to exceed value d_1 . The length of the longest sealed compartment shall be taken to be l in order to determine Q_2 .

In these formulae:

- l = the length of the corresponding sealed compartment, in m;
- d_1 = the calculated internal diameter of the drainage pipe, in mm;
- d_2 = the calculated internal diameter of the drainage spur, in mm.

8-1.6.4 Where the drainage pumps are connected to a drainage system, the drainage pipes shall have an internal diameter of at least d_1 , in mm, and the drainage spurs an internal diameter of at least d_2 , in mm. Where vessels are less than 25 m in length, these values may be reduced to 35 mm.

8-1.6.5 Only self-priming drainage pumps are acceptable.

8-1.6.6 There must be at least one strainer on both the starboard and port sides of all flat-bottomed, drainable compartments that are wider than 5 m.

8-1.6.7 It may be possible to drain the after-peak to the main engine room by means of an easily accessible self-closing valve attached to the after-peak bulkhead.

8-1.6.8 The drainage spurs for the various compartments shall be linked to the bilge main by means of closing and non-return valves or equivalent devices.

The compartments or other spaces fitted out for ballast may only be linked to the drainage system by means of a single closing device. That requirement shall not apply to holds fitted out for ballast. Such holds shall be filled with ballast water by means of ballast piping that is permanently installed and independent of the drainage pipes, or by means of spurs consisting of flexible pipes or intermediate pipes that can be connected to the main drain. Water intake valves located in the base of the hold shall not be permitted for this purpose.

8-1.6.9 The hold bottoms shall be fitted with depth gauges.

8-2 AUTOMATION

8-2.1 Scope

The provisions of this section are to be complied with, if no continuous watch is kept in the engine room.

8-2.2 General provisions

8-2.2.1 Automation systems and their elements should comply with the requirements of 9-1.1, 9-2.18 and 9-2.19.

8-2.2.2 The main machinery and its essential auxiliaries shall be equipped for unattended operation in the machinery space. Remote control, alarm and safety systems shall be such as to ensure smooth functioning of the plant and effective monitoring of all its important parts.

8-2.2.3 Care shall be taken to ensure that, in the event of a malfunction of the automation systems or breakdown of the electrical, pneumatic or hydraulic supply system for it, the controlled components remain in the condition in which they were before the failure. The failure shall be signalled.

8-2.2.4 Automated or remote-controlled machinery shall also be equipped with local manual controls. The manual controls shall be such that they cannot be put out of action by any breakdown of the automated or remote-controlled system.

8-2.2.5 It shall be possible to keep the remote control or automated control system supplied with energy from the second source, which shall come into operation automatically upon failure of the main supply source. If the second power source is not permanently available while the vessel is under way, a buffer device is required.

8-2.2.6 Automation system devices are to be so constructed that their function can be checked during the operation of the plant.

8-2.2.7 On the remote control station, it shall be indicated that the given commands have been executed.

8-2.3 Remote control and automated remote control of propulsion installation

8-2.3.1 Automated remote control or remote control of the propulsion installation shall be possible only from one station at a time. Secondary control stations interconnected with the control mechanisms in the wheelhouse are allowed. If there is more than one control station, an indicator shall be fitted at each station showing from which station the installation is controlled.

The changeover of control between the wheelhouse and the engine room shall be possible only from the wheelhouse.

8-2.3.2 The main machinery shall be equipped with an emergency stopping device in the wheelhouse, independent of the automated remote control system or remote control system.

8-2.3.3 The design of the automated remote control system or remote control system shall be such, that in the event of its failure, an alarm will be given and the present speed and direction of propulsion will be maintained until another control is in operation.

8-2.3.4 Indicators shall be fitted in the wheelhouse for the direction of the propulsion thrust imparted to the vessel and the rotational speed of the propellers.

8-2.3.5 Where the remote control system of the propulsion installation is automated, the number of successive automatic attempts to produce a start shall be limited in order to keep enough air pressure for starting. A signal lamp shall light up at the lowest air pressure still sufficient for starting the main machinery.

8-2.4 Alarm system

8-2.4.1 The alarm system shall sound an acoustic signal in the wheelhouse and engine room and actuate visual signals for each separate alarm function.

8-2.4.2 The alarm system has to comply with the requirements of 9-2.17.1.

8-2.5 Safety system

8-2.5.1 A safety system shall be provided, such that a breakdown in the machinery or boilers presenting an immediate danger, will initiate the automatic shutdown of the affected part of the plant and activate an alarm.

8-2.5.2 The wheelhouse shall be equipped with devices overriding the safety system of the main machinery with the exception of protection against over speeding, as well as an alarm indicating that the safety system has been switched off.

8-2.6 Fire detection system for the machinery space

8-2.6.1 A fire detection system, self-monitoring and with facilities for periodic testing, shall be installed in the machinery space.

8-2.6.2 The fire-detection system shall be capable of detecting rapidly an outbreak of fire in any part of the machinery space under any normal conditions of operation of the machinery. The detection system shall actuate acoustic and visual alarms, different from the signals emitted by any other system, in the wheelhouse and places where they can be heard or seen by the crew member on duty.

8-2.6.3 It shall be possible to keep the fire detection system supplied with energy from the second source, which shall come into operation automatically upon failure of the main supply source. If the second power source is not permanently available, a buffer device is required.

8-2.7 Bilge-level alarm

A bilge-level alarm system shall be fitted in all machinery spaces. The level sensor or sensors shall be suitably placed to ensure an early warning.

8-2.8 Standby installations

Where the equipment of importance for the safety of navigation is backed up by standby units, an automatic changeover device shall be provided that actuates a signal when operated.

CHAPTER 8A
EXHAUST AND POLLUTANT
PARTICULATE EMISSIONS FROM DIESEL ENGINES

8A-1 DEFINITIONS

8A-1.1 For the purposes of this chapter:

8A-1.1.1 “Engine”: an engine operating according to the compression-ignition principle (diesel engine), including main and auxiliary machinery engines;

8A-1.1.2 “Remanufactured engine”: a reconditioned second-hand engine, similar to the engine replaced in terms of power, rating and conditions of installation;

8A-1.1.3 “Type approval”: the decision whereby the competent authority certifies that an engine type, family or group meets the technical requirements of this chapter in respect of emissions of engine exhaust and air-pollutant particulates;

8A-1.1.4 “Installation check”: the procedure whereby the competent authority ascertains that an engine installed in a vessel meets the technical requirements of this chapter as regards exhaust and air-pollutant emissions, including those occurring after any modifications and adjustments which may have taken place after type approval;

8A-1.1.5 “Interim check”: the procedure whereby the competent authority ascertains that an engine installed in a vessel meets the technical requirements of this chapter as regards exhaust and air-pollutant emissions, including those occurring after any modifications and/or adjustments which may have taken place after the mounting check;

8A-1.1.6 “Special check”: the procedure whereby the competent authority ascertains that an engine used on board a vessel still meets the technical requirements of this chapter as regards exhaust and air-pollutant emissions after each major modification;

8A-1.1.7 “Engine type”: a batch of engines which are identical in terms of the essential features of the engine; at least one unit of the engine type must be constructed;

8A-1.1.8 “Engine family”: a grouping of engines by the manufacturer, approved by the competent authority, which as a result of their design must all have similar features as regards the level of exhaust and air-pollutant particulate emissions and meet the requirements of this chapter;

8A-1.1.9 “Engine group”: a group of engines selected by the manufacturer, approved by the competent authority, which as a result of their design must all have similar features as regards the level of exhaust and air-pollutant particulate emissions and meet the requirements of this chapter, the adjustment or modification of individual engines being permissible after the type approval within fixed limits;

8A-1.1.10 “Rated power”: the net power of the engine at rated speed and at full load;

8A-1.1.11 “Type approval certificate”: the document by which the competent authority certifies the type approval;

8A-1.1.12 “Collection of engine parameters”: the document containing all the parameters, including the parts (components) and adjustments of the engine, which have an impact on exhaust and air-pollutant particulate emissions and their modifications.

8A-2 FUNDAMENTAL PRINCIPLES

8A-2.1 This chapter shall apply to all engines of a net power equal to or greater than 37 kW installed on board vessels.

8A-2.2 Carbon monoxide (CO), hydrocarbon (HC), oxide of nitrogen (NO_x) and particulate (PT) emissions from these engines shall not exceed the following values, in terms of the swept volume per cylinder in litres (SV):

| Category | Swept volume SV [l] Net power P [kW] | Carbon monoxide (CO) [g/kWh] | Sum of hydrocarbons and oxides of nitrogen (HC+NO _x) [g/kWh] | Particulates (PM) [g/kWh] |
|----------|---|------------------------------------|---|---------------------------------|
| 1 | 2 | 3 | 4 | 5 |
| V1:1 | $SV \leq 0.9$ and $P \geq 37$ | 5.0 | 7.5 | 0.4 |
| V1:2 | $0.9 \leq SV < 1.2$ | 5.0 | 7.2 | 0.3 |
| V1:3 | $1.2 \leq SV < 2.5$ | 5.0 | 7.2 | 0.20 |
| V1:4 | $2.5 \leq SV < 5$ | 5.0 | 7.2 | 0.20 |
| V2:1 | $5 \leq SV < 15$ | 5.0 | 7.8 | 0.27 |
| V2:2 | $15 \leq SV \leq 20$ and $P < 3,300$ | 5.0 | 8.7 | 0.50 |
| V2:3 | $15 \leq SV < 20$ and $P \geq 3,300$ | 5.0 | 9.8 | 0.50 |
| V2:4 | $20 \leq SV < 25$ | 5.0 | 9.8 | 0.50 |
| V2:5 | $25 \leq SV < 30$ | 5.0 | 11.0 | 0.50 |

Or, alternatively, in terms of rated power P_N :

| Rated power P_N [kW] | Carbon monoxide (CO) [g/kWh] | Hydro- carbons (HC) [g/kWh] | Oxides of nitrogen (NO _x) [g/kWh] | Particulates (PM) [g/kWh] |
|------------------------------|---------------------------------------|--------------------------------------|---|---------------------------------|
| 1 | 2 | 3 | 4 | 5 |
| $37 \leq P_N < 75$ | 5.0 | 1.3 | 7.0 | 0.4 |
| $75 \leq P_N < 130$ | 5.0 | 1.0 | 6.0 | 0.3 |
| $130 \leq P_N < 560$ | 3.5 | 1.0 | 6.0 | 0.2 |
| $P_N \geq 560$ | 3.5 | 1.0 | $n \geq 3,150 \text{ min}^{-1} = 6.0$ $343 \leq n < 3,150 \text{ min}^{-1} = 45 \cdot n^{(-0.2)} - 3$ $n < 343 \text{ min}^{-1} = 11.0$ | 0.2 |

8A-2.3 The requirements in paragraph 8A-2.2 shall not apply to engines installed on board prior to 1 July 2009, nor to remanufactured engines installed prior to 31 December 2011 inclusive, on board vessels in service at 31 December 2006.

8A-2.4 Compliance with the requirements of paragraph 8A-2.2 shall be checked by using the ISO test procedure as specified in ISO 8178-4:1996 and IMO MARPOL 73/78, Annex VI (NO_x Code).

8A-2.5 Compliance with the requirements of paragraph 8A-2.2 by an engine type, group or family shall be observed by means of a type inspection. The type inspections shall be certified by a type approval certificate. Type approvals for all engines shall be granted according to UNECE Regulation No. 96 Concerning the Adoption of Uniform Conditions of Approval and Reciprocal Recognition of Approval for Motor Vehicle Equipment and Parts. The owner or his representative shall be required to present a copy of the type approval certificate to the competent authority on the inspection of vessels with a view to obtaining a ship's certificate in accordance with the provisions of chapter 2. A copy of the type approval certificate and the collection of engine parameters shall also be on board.

8A-2.6 After the installation of the engine on board, but before it is brought into service, an installation check shall be made. This check, which is part of the initial inspection of the vessel or of a special inspection justified by the installation of the engine in question, leads either to the registration of the engine in the first ship's certificate drawn up or to an amendment to the existing ship's certificate.

8A-2.7 Interim engine checks shall be effected as part of a periodical inspection in accordance with paragraph 8A-2.4.

8A-2.8 A special check shall be made after each major modification to the engine with an impact on exhaust and air-pollutant particulate emission.

8A-2.9 The type approval and identification numbers (designated and arranged according to UNECE Regulation No. 96) of all the engines referred to in this chapter installed on board a vessel shall be registered in the ship's certificate by the competent authority on the inspection of vessels.

CHAPTER 8B
PREVENTION OF WATER POLLUTION AND ABATEMENT
OF NOISE PRODUCED BY VESSELS

8B-1 REQUIREMENTS FOR COLLECTION FACILITIES FOR USED OIL AND OIL-CONTAINING WATER

8B-1.1 All necessary steps should be taken to reduce the leakage of oil on board vessels. Drip-trays to collect any leaking fuel or other oils shall be placed under fittings of fuel and other oil tank connections. The contents of drip trays shall be conveyed to collecting tanks.

8B-1.2 Vessels having installations which use liquid fuel on board shall be equipped with:

- (i) collecting reservoirs for oil containing water;
- (ii) systems for draining oil-containing water to the-collecting reservoirs;
- (iii) standard connections for the discharge of oil-containing water to reception facilities outside the vessel.

The Administration may consider the engine-room bilges as a collecting reservoir for oil-containing water.

8B-1.3 Tanks used as reservoirs must be fitted with:

- (i) an orifice for access and cleaning;
- (ii) a breather pipe with a flame-arrester leading to the open air;
- (iii) a device which activates optical and acoustic signals in the wheelhouse or the central control post when the level of the liquid reaches 80 per cent of the tank capacity;
- (iv) a device for measuring the level of the liquid;
- (v) If heavy fuel is used on the vessel or the tank is installed in a place where negative temperatures are possible during operation, the tank shall be fitted with a heating facility.

8B-1.4 Standard discharge connections shall conform to the requirements of Basin administrations and shall be of either flange or quick-release type. Flange-type connections are fitted with a flange with an outer diameter of 215 mm and six slotted holes of 22 mm on a pitch circle diameter of 183 mm. The flange is intended for pipes with an internal diameter of up to 125 mm, has a thickness of 20 mm and is to be manufactured from steel or an equivalent material with a flat machined surface. The flange, together with a gasket of oil-resistant material, must be designed for a working pressure of 0.6 MPa. Coupling is effected by means of six 20 mm-diameter bolts of the requisite length. Standard discharge connections are to be fitted with blank flanges.

Quick-release type connections shall conform to a recognized European standard.

A stop button for the transfer pump, if any, must be installed in the vicinity of the discharge connections.

8B-1.5 The installations for draining the machinery space shall be so arranged that any oil or oil-containing water shall remain aboard. Where a drainage system incorporates permanently fixed pipes, the bilge drainage pipes shall be fitted with closing devices sealed in the closed

position by the Administration. The number and position of those closing devices shall be mentioned in the ship's certificate.

8B-1.6 In order to store spent oils there shall be one or several specific receptacles in the engine room with total capacity corresponding to at least 1.5 times the quantity of the spent oils from the sumps of all of the internal combustion engines and all of the equipment installed, together with the hydraulic-fluid installations.

Should operating conditions so require, the Administration may prescribe other standards for the dimensions of these receptacles. If the total quantity of oil contained in the sumps of all of the internal combustion engines and all of the equipment installed, together with the hydraulic fluid systems is 300 litres or more, the receptacles shall be fixed and be fitted with a device which activates optical and acoustic signals in the wheelhouse or the central control post when the level of the liquid reaches 80 per cent of the receptacle capacity.

8B-1.7 For vessels operated over short distances only or for ferries, the Administration may no longer require the receptacles mentioned in 8B-1.6.

8B-2 REQUIREMENTS CONCERNING EQUIPMENT FOR PROCESSING OIL-CONTAINING WATER

8B-2.1 The Administration may allow the use of separation and filtration equipment. In this case such equipment and its components shall meet the conditions required by the Administration.

8B-2.2 In cases where discharges of any oil/water mixtures are generally prohibited on waterways, the Administration may put oil separation and filtration devices out of action by sealing.

8B-3 REQUIREMENTS CONCERNING FACILITIES FOR COLLECTING AND STORING DOMESTIC WASTE WATER

8B-3.1 Vessels having or intended to have on board more than the maximum number of people that the relevant Basin administration will allow before domestic waste water retention or treatment facilities are required on board, shall be equipped with:

- (i) a collecting tank for domestic waste-water;
- (ii) systems for transferring domestic waste water to the collecting tank and discharging it from the tank to reception facilities outside the vessel or overboard in areas and under conditions which are allowed;
- (iii) standard assemblies for the discharge of domestic waste water to reception facilities,

or, alternatively, with a domestic waste water treatment plant according to paragraph 8B-4 below.

Administrations may apply requirements different from those in 8B-3.1 with regard to equipment of vessels navigating within its inland waterways.

8B-3.2 The volume of domestic waste-water collection tanks,

V_{ww} shall be calculated by the following formula:

$$V_{ww} = G_{ww} \times N \times T,$$

where G_{ww} = domestic waste-water discharge per person per day according to operating conditions;

N = maximum admissible number of people on board;

T = period between emptyings of the on-board tanks in days.

8B-3.3 Tanks must be fitted with a device which activates optical and acoustic signals in the wheelhouse or the central control post when the level of the liquid reaches 80 per cent of the tank capacity.

8B-3.4 Tanks shall have a smooth inner surface (i.e., framework and fittings on the outside) and a bottom sloping towards the drain.

8B-3.5 Tanks shall be fitted with installations for breaking up sediment and cleaning.

8B-3.6 For purposes of discharge of the tanks, vessels shall be equipped with pumps. Pumps need not be fitted on small vessels.

8B-3.7 Standard discharge connections shall conform to the requirements of Basin administrations and shall be of either flange or quick-release type. Flange-type connections are fitted with a flange with an outer diameter of 210 mm and four slotted holes of 18 mm on a pitch circle diameter of 170 mm. The flange is intended for pipes with an internal diameter of up to 100 mm, has a thickness of 16 mm and is to be manufactured from steel or an equivalent material with a flat machined surface. The flange, together with a gasket, must be designed for a working pressure of 0.6 MPa. Coupling is effected by means of four 16 mm-diameter bolts of the requisite length. Standard discharge connections are to be fitted with blank flanges.

Quick-release type connections shall conform to a recognized European standard.

8B-4 REQUIREMENTS CONCERNING EQUIPMENT FOR THE TREATMENT OF DOMESTIC WASTE WATER

The Administration may allow the use of the equipment for the treatment of domestic waste water. In this case such equipment and its components shall meet the conditions required by the Administration.

8B-5 FACILITIES FOR THE COLLECTION AND STORAGE OF VESSEL OPERATION REFUSE

A separate container must be provided for vessel operation refuse.

8B-6 FACILITIES FOR THE COLLECTION, STORAGE AND TREATMENT OF HOUSEHOLD REFUSE

8B-6.1 Manned vessels and passenger vessels must be equipped with facilities for the collection of household refuse.

8B-6.2 The volume of household refuse collection facilities, V_{hr} shall be calculated by the formula:
$$V_{hr} = G_{hr} \times N \times T$$

where G_{hr} = household refuse discharge per person per day according to operating conditions;

N = maximum admissible number of people on board;

T = period between emptyings of the on-board collection facilities.

8B-6.3 Household refuse-collection devices must have easy-to-clean internal surfaces.

8B-6.4 Household refuse-collection equipment must have tightly-closing lids and be installed in well-ventilated areas, preferably on the open deck, and must have fittings allowing them to be securely attached to the deck.

8B-6.5 Removable equipment must be designed in such a way that it can be moved by one or two people. Otherwise, appropriate additional equipment must be provided for transport.

8B-6.6 For small vessels, household refuse may be collected in disposable dense polyethylene bags.

8B-7 REQUIREMENTS CONCERNING FACILITIES FOR THE ELIMINATION OF HOUSEHOLD AND VESSEL OPERATION REFUSE

8B-7.1 The Administration may allow the use of a household and vessel operation refuse incinerator. In this case, such equipment and its components shall meet the conditions required by the Administration.

8B-7.2 In cases where the operation of household and vessel operation refuse incinerators is prohibited on certain waterways, the Administration may put such devices out of action by sealing.

8B-8 NOISE EMITTED BY VESSELS

8B-8.1 Noise emitted by vessels under way, in particular engine intake and exhaust noise, shall be damped by appropriate means.

8B-8.2 Noise emitted by vessels shall not exceed 75 dB(A) at a lateral distance of 25 m from the shipside.

8B-8.3 With the exception of trans-shipment operations, the noise emitted by stationary vessels shall not exceed 65 dB(A) at a lateral distance of 25 m from the shipside.

CHAPTER 9 ELECTRICAL INSTALLATIONS

9-1 GENERAL

9-1.1 General requirements

9-1.1.1 Where there are no specific requirements concerning certain parts of an installation the safety level shall be considered satisfactory where those parts have been produced in accordance with an approved European standard or in accordance with the requirements of a recognized Classification Society. The relevant documents shall be submitted to the competent authority on inspection of vessels.

9-1.1.2 The electrical and electronic equipment shall be designed for permanent lists of up to 15° and ambient inside temperatures of between 0 and +40°C, and on the deck between -20°C and +40°C. It shall function perfectly at those limits. The Administration may extend the outside temperature range in accordance with local climatic conditions.

9-1.1.3 The electrical and electronic equipment and appliances shall be fully accessible and easy to maintain.

9-1.2 Electrical supply systems

9-1.2.1 Where vessels are fitted with an electric system that system shall have at least two power sources in such a way that where one power source fails the remaining source is able to supply the equipment needed for navigational safety for an appropriate period of time to be determined by the Administration of the river basin.

9-1.2.2 Adequate sizing of the power supply shall be demonstrated by means of a power balance. An appropriate simultaneity factor may be taken into account.

9-1.3 Documents required to be available on board

Documents containing the following, and duly stamped by the competent authority on inspection of vessels, shall be kept on board:

- (i) a set of instructions for use and a description of the electrical installations;
- (ii) wiring diagrams concerning all of the electrical equipment;
- (iii) switching diagrams for the main control panel, the emergency-installation panel and the distribution panels, together with the most important technical data such as the amperage and rated current of the protection and control devices;
- (iv) power data concerning the electrical service equipment;
- (v) types of cable and statement of conductor cross sections;
- (vi) all other particulars essential for an assessment of safety.

It is not necessary to keep such documents on board unmanned vessels, but they must be available at all times from the owner.

9-2 TECHNICAL REQUIREMENTS**9-2.1 Maximum permissible voltages****9-2.1.1 The following voltages shall not be exceeded:**

| Type of installation | Maximum permissible voltage | | |
|---|-----------------------------|----------------------------------|---------------------------------|
| | Direct current | Single-phase alternating current | Three-phase alternating current |
| a. Power and heating installations including the relevant sockets | 250 V | 250 V | 500 V |
| b. Lighting, communications, command and information installations, including the relevant sockets | 250V | 250V | - |
| c. Sockets intended to supply portable devices used on open decks or within narrow or damp metal lockers, apart from boilers and tanks: | | | |
| 1. In general | 50V | 50V1) | - |
| 2. Where a circuit-separation transformer only supplies one appliance | - | 250V2) | - |
| 3. Where protective-insulation (double insulation) appliances are used | 250V | 250V | - |
| 4. Where <30 mA default current circuit breakers are used | - | 250V | 500V |
| d. Mobile components such as electrical equipment for containers, blowers and mobile pumps which are not normally handled during service and use conducting parts which are open to physical contact are earthed by means of a protective conductor that is incorporated into the connecting cable and which, in addition to that effective conductor, are connected to the hull by their location or another conductor | 250V | 250V | 500V |
| e. Sockets intended to supply portable appliances used inside boilers and tanks | 50V1) | 50V1) | |
| Comments: | | | |
| 1) Where that voltage comes from higher-voltage networks galvanic separation must be used (isolating transformer). | | | |
| 2) All of the poles of the secondary circuit shall be insulated from the earth. | | | |

9-2.1.2 If the required protective measures are applied higher voltages are acceptable:

- (i) for power installations where their power so requires;
- (ii) for special on-board installations such as radio and ignition systems.

9-2.2 Protection against physical contact, the insertion of solid objects and the infiltration of water

The type of minimum protection for parts of permanent fixtures shall be as set out in the table below or may be stricter in accordance with the requirements of the Administration.

| Location | Type of minimum protection (in accordance with IEC publication 529) | | | | | |
|---|--|--------|------------------------|------------------------------------|---------------------------|--------------------------------|
| | Generators | Motors | Transformers | Panels Distributors Switches | Installation equipment | Lighting devices |
| Service premises, engine rooms, steering-gear compartments | IP 22 | IP 22 | ²⁾ IP 22 | ¹⁾²⁾ IP 22 | IP 44 | IP 22 |
| Holds | | | | | IP 55 | IP 55 |
| Battery and paint lockers | | | | | | IP 44 u. (EX) ³⁾ |
| Unroofed decks and steering positions | | IP 55 | | IP 55 | IP 55 | IP 55 |
| Enclosed wheelhouse | | IP 22 | IP 22 | IP 22 | IP 22 | IP 22 |
| Accommodation apart from health facilities and washrooms | | | | IP 22 | IP 20 | IP 20 |
| Health facilities and washrooms | | IP 44 | IP 44 | IP 44 | IP 55 | IP 44 |
| Remarks 1. Where appliances release large amounts of heat: IP 12 2. Where appliances or panels do not have this type of protection their location shall meet the conditions applying to that type of protection. 3. Electrical equipment of the certified safety type in accordance with IEC Publication 79. | | | | | | |

9-2.3 Explosion proofing

Only electrical equipment that has been explosion proofed, (safety-certified) may be installed in premises where potentially explosive gases or mixtures of gases are likely to accumulate, such as compartments set aside for accumulators or the storage of highly inflammable products. No light switches or other electrical appliances shall be installed on those premises. The explosion proofing shall take account of the characteristics of the potentially explosive gases or mixtures of gases that are likely to arise (explosion-potential group, temperature class).

9-2.4 Distribution systems

9-2.4.1. The following distribution systems are allowed for direct and single-phase alternating current:

- (i) two-conductor systems of which one is earthed;
- (ii) single-conductor systems using the hull-return principle, only for local installations (for example, starting gear for combustion engines, cathodic protection);
- (iii) two-conductor systems that are insulated from the hull.

9-2.4.2 The following distribution systems are allowed for three-phase alternating current:

- (i) four-conductor systems with earthing of the neutral point, not using the hull return principle;

- (ii) three-conductor systems insulated from the hull;
- (iii) three-conductor systems with earthing of the neutral point using the hull return principle except for terminal circuits.

9-2.4.3 All such systems shall comply with the rules of the Administration or of a recognized Classification Society.

9-2.4.4 The use of other distribution systems shall be subject to the prior consent of the Administration.

9-2.4.5 Connection to the shore or other external networks

9-2.4.5.1 Incoming supply lines from land-based networks or other external networks to the installations of the onboard network shall have a permanent connection on board in the form of fixed terminals or fixed plug sockets. The cable connections shall not be subjected to any pulling load.

9-2.4.5.2 The hull shall be capable of being earthed effectively when the connection voltage exceeds 50 V. The earthing connection shall be specially marked.

9-2.4.5.3 Means shall be provided to prevent the concurrent operation of the onboard network generators and the shore network or another external network. A brief period of concurrent operation shall be permitted when changing from one system to another without a break in voltage.

9-2.4.5.4 The connection shall be protected against short circuits and overloads.

9-2.4.5.5 The main switchboard shall indicate whether the connection is live.

9-2.4.5.6 Indicator devices shall be installed to enable polarity to be compared, in the case of direct current, and phase sequence in the case of alternating current, between the connection and the onboard network.

9-2.4.5.7 A panel on the connection shall indicate:

- (i) the measures required to make the connection;
- (ii) the types of current and the nominal voltage and, for alternating current, the frequency.

9-2.4.6 Power supply to other vessels

9-2.4.6.1 When power is supplied to other vessels, a separate connection shall be used.

9-2.4.6.2 If power sockets rated at more than 16 A are used to supply current to other vessels, steps shall be taken to ensure (for example, by the use of switches or interlocks) that connection and disconnection can take place only when the line is dead.

9-2.4.6.3 Cables and their connections shall not be subjected to any pulling load.

9-2.4.6.4 Instruction plates shall be affixed to power supply connections and to coupling devices, stipulating that feeders must be disconnected before vessels are uncoupled.

9-2.4.6.5 The supply to the pushed barges of a convoy shall be controlled by means of switches installed on the pusher.

9-2.4.6.6 Paragraphs 9-2.4.5.3 - 9-2.4.5.7 shall apply by analogy.

9-2.5 Generators and motors

Generators and motors shall be so installed as to be readily accessible for inspection, measurements and repairs and as to prevent water and oil from reaching the windings. Terminal boxes shall be readily accessible, amply dimensioned and sufficiently waterproof. The type of protection should be in accordance with the table in 9-2.2 above.

9-2.6 Accumulators

9-2.6.1 The accumulators shall be of a construction suitable for use on board a vessel. They shall be grouped in boxes or trays fitted with grips to facilitate handling. Cell boxes shall be made of a shock-resistant material that does not easily catch fire and shall be so made as to prevent any spillage of electrolyte at an inclination of 40° from the vertical.

9-2.6.2 Accumulators shall be so arranged as not to shift with the movements of the vessel. They shall not be exposed to excessive heat, extreme cold, spray, steam or vapour. Accumulator batteries shall be installed so as to permit easy access for replacement, topping up and cleaning of the elements, with a space of not less than 15 mm all around them to allow air to circulate, and with no more than 1.5 m. separating the deck from the plugs in the uppermost bank. If accumulators are installed on two or more shelves one above the other, at least 50 mm space shall be left at the front and back of each shelf to allow air to circulate.

Accumulator batteries shall not be installed in the wheelhouse, accommodation or holds.

This requirement shall not apply to accumulators for portable appliances, or to accumulators requiring a charging power of less than 0.2 kW.

9-2.6.3 Accumulator batteries requiring a charging power of more than 2 kW (calculated from the maximum charging current and the nominal voltage of the battery) shall be installed in a special battery room. If placed on deck, they shall be enclosed in a cupboard or chest.

Accumulator batteries requiring a charging power not exceeding 2 kW may be installed below decks in a cupboard or chest. They may be installed in the machinery space or any other well-ventilated place provided that they are protected against falling objects and dripping water.

Special battery rooms shall be capable of being heated when the temperature inside them falls below 5°C.

9-2.6.4 The interior surfaces of all battery rooms, including cupboards, lockers, shelving and other built-in fixtures, shall be protected against action of the electrolyte by a coat of paint or a lining made of a material resistant to the electrolyte.

9-2.6.5 Provision shall be made for effective ventilation when batteries are installed in a closed compartment, cupboard or chest. Forced-draught ventilation shall be provided for nickel-cadmium accumulators requiring a charging power of more than 2 kW and for lead-acid accumulators requiring more than 3 kW.

The air shall enter at the bottom and be discharged at the top so that the whole of the battery is swept by the air stream. Ventilation ducts shall not include devices which obstruct the air flow.

The minimum air throughput for ventilation, in m³/hour, shall be calculated by the following formula:

$$Q = 0.11 \cdot I \cdot n$$

where: I represents, in amperes, the maximum charging current (it shall be not less than one quarter of the maximum current admissible by the charging device);
 n represents the number of cells.

9-2.6.6 Where natural ventilation is used, the cross-section of the ducts shall be sufficient for the required air throughput at an air-flow velocity of 0.5 m/sec. It shall be not less than 80 cm² for lead batteries and not less than 120 cm² for alkaline batteries.

9-2.6.7 Where the required ventilation cannot be obtained by natural air flow, an exhauster fan shall be provided; its motor shall be clear of the gas stream.

Special devices shall be provided to prevent gases from entering the motor.

Fans shall be of a construction and material precluding the production of sparks through contact between a blade and the fan casing. In addition, the material shall be such as to dissipate any electrostatic charges. Warning symbols "No naked lights or fires and no smoking" corresponding to sketch 2 of appendix 3 with a diameter of at least 10 cm shall be placed on the doors of rooms or cupboards, or the covers of chests, containing batteries.

9-2.7 Electrical switchboards

9-2.7.1 Switchboards shall be situated in accessible and well-ventilated places and be protected against water and mechanical damage.

Switchboards shall not be placed near sounding pipes or near the vent pipes of liquid-fuel tanks.

No pressure pipes shall be situated above the main or emergency switchboard or the control panels of propulsion equipment. In vessels where this requirement cannot be met, no pipe joint shall be installed above an electrical switchboard.

9-2.7.2 In general, materials used in the construction of switchboards shall have suitable mechanical strength and be durable, flame-retardant and self-extinguishing. They shall not be hygroscopic.

9-2.7.3 Where the voltage exceeds the safe voltage:

- (i) The current-carrying components shall be so arranged or protected as to prevent accidental personal contact;
- (ii) An insulating mat or an impregnated wooden grating shall be provided; this shall not apply, however, to subdistribution panels;
- (iii) Metal parts of the frames or substructures of control devices and the metal casings of appliances shall be carefully earthed.

9-2.7.4 All parts of switchboards, including the connections, shall be readily accessible for inspection, maintenance or replacement.

9-2.7.5 Marker plates for all circuits shall be affixed to switchboards.

9-2.8 Switches, protective devices

9-2.8.1 Generator circuits and consumer circuits shall be protected against short circuits and overcurrent on all non-earthed conductors. Overload circuit-breakers or fuses may be used for this purpose. Circuits supplying the steering-gear motors (steering installations) and fire pumps and their control circuits shall only be protected against short circuits. Where circuits include thermal circuit-breakers these shall be neutralized or set at not less than twice the nominal amperage and fitted with an emergency warning light indicating overloading.

9-2.8.2 Outputs from the main switchboard to appliances operating at more than 16 A shall include a load or power switch.

9-2.8.3 Power consumers for the propulsion of the vessel, the steering system, the rudder position indicator, navigation or safety systems, and appliances with a nominal amperage greater than 16 A shall be supplied by separate circuits.

9-2.8.4 The circuits of appliances required for propelling and manoeuvring the vessel shall be supplied directly by the main switchboard.

9-2.8.5 Circuit-breaking equipment shall be selected on the basis of nominal amperage, thermal or dynamic strength, and their breaking capacity. Switches shall simultaneously cut off all live conductors. The switching position shall be identifiable.

9-2.8.6 Fuses shall be of the enclosed-melt type and be made of porcelain or an equivalent material. It shall be possible to change them without any danger of operator contact.

9-2.9 Measuring and monitoring devices

9-2.9.1 Generator, battery and distribution circuits shall be equipped with measuring and monitoring devices where the safe operation of the installation so requires.

9-2.9.2 Non-earthed networks where the voltage is higher than 50 V, must include an earth-insulation checking device equipped with a visual and audible alarm. In secondary installations such as control circuits, this device may be dispensed with.

9-2.10 Emergency circuit breakers

Emergency circuit breakers for oil burners, fuel pumps, fuel separators and engine-room ventilators shall be installed outside the premises containing the equipment.

9-2.11 Fixed installations

9-2.11.1 Equipment seals shall be sized as a function of the cables to be connected and be appropriate to the types of cable used.

9-2.11.2 Sockets for distribution circuits at different voltages or frequencies shall be impossible to confuse.

9-2.11.3 Switches shall simultaneously switch off all unearthed conductors within a circuit. However, single-pole switches within unearthed circuitry shall be permitted in accommodation-lighting circuits apart from in laundries, bathrooms and washrooms.

9-2.11.4 Where amperage exceeds 16 A it shall be possible to lock the sockets by means of a switch in such a way that the plug can only be inserted and withdrawn with the power switched off.

9-2.12 Cables

9-2.12.1 Cables shall be flame-retardant, self-extinguishing and resistant to water and oil. In accommodation, other types of cable may be used, provided that they are effectively protected, have flame-retardant characteristics and are self-extinguishing.

9-2.12.2 Cables with conducting wires with a minimum cross-section of 1.5 mm² shall be used for power circuits and of 1.0 mm² for lighting circuits.

9-2.12.3 The armouring and metal sheathing of power and lighting circuits shall not, under normal operating conditions, be used as conductor wires or earth wires.

9-2.12.4 The armouring and metal sheathing of power and lighting circuits shall be earthed at least at one end.

9-2.12.5 The cross-section of conductor wires shall take account of the final permissible maximum temperature of conductor wires (maximum permissible amperage) and permissible voltage drop. Such a drop between the main switchboard and the furthest consumer on the circuit shall not be more than 5% of nominal voltage for lighting or more than 7% for power or heating circuits.

9-2.12.6 Cables shall be protected against mechanical damage.

9-2.12.7 The means of fixing the cables shall ensure that any pulling load remains within the permissible limits.

9-2.12.8 When cables pass through partitions or decks, the mechanical strength, watertightness and fire resistance of these partitions and decks shall not be affected by the seals.

9-2.12.9 Cables linking mobile wheelhouses shall be sufficiently flexible and be fitted with insulation with sufficient flexibility down to -20°C and resistance to steam and vapour, ultraviolet rays, ozone, etc.

9-2.13 Lighting

9-2.13.1 In spaces in which accumulators are installed or paint and other highly inflammable substances are stored, limited-explosion-risk lighting appliances shall be used.

9-2.13.2 Lighting appliances shall be so installed that the heat they emit cannot set fire to nearby inflammable objects or components.

9-2.13.3 Lighting appliances on open decks shall be so installed as not to impede the recognition of signal lights.

9-2.13.4 When two or more lighting appliances are installed in the machinery space, as defined in 1-2, they shall be supplied by at least two different circuits.

9-2.14 Signal lights

9-2.14.1 The switchboards for the signal lights shall be installed in the wheelhouse. They shall be supplied by a separate feeder from the main switchboard or by two separate secondary networks.

9-2.14.2 Lights shall be individually supplied from the lighting panel and be individually protected and controlled.

9-2.14.3 Tell-tale lamps or other equivalent devices monitoring the signal lights shall be placed on the switchboard in the wheelhouse. No fault in the monitoring installation mentioned in 7-1.6 shall affect the operation of the light which it monitors.

9-2.14.4 Several lights forming a functional unit and installed together at the same point may be jointly supplied, controlled and monitored. The monitoring installation shall be capable of identifying the failure of any of these lights. However, it shall not be possible to use both light sources in a double light (two lights mounted one above the other or in the same housing) simultaneously.

9-2.15 Earthing

9-2.15.1 Electrical equipment operating at a voltage of more than 50 V needs to be earthed.

9-2.15.2 Metal parts of electrical equipment that are not electrically live and can be touched by people, such as machinery frames and casings, appliances and lighting equipment, shall be earthed separately where these are not in electrical contact with the hull as a result of their installation.

9-2.15.3 The housings of mobile electrical consumers and portable appliances shall be earthed by means of an additional conductor that is incorporated into the power cable.

That prescription does not apply where a circuit-separation transformer is used, nor to appliances fitted with protective insulation (double insulation).

9-2.15.4 The cross section of the earthing conductors shall be not less than as set out in the table below:

| Cross section of outside conductors (mm ²) | Minimum cross section of earthing conductors | |
|--|---|---|
| | in insulated cables (mm ²) | fitted separately (mm ²) |
| from 0.5 to 4 | same cross section as that of the outside conductor | 4 |
| more than 4 to 16 | same cross section as that of the outside conductor | same cross section as that of the outside conductor |
| more than 16 to 35 | 16 | 16 |
| more than 35 to 120 | half of the cross section of the outside conductor | half of the cross section of the outside conductor |
| more than 120 | 70 | 70 |

9-2.16 Emergency source of electric power

9-2.16.1(i) Every vessel navigating in zone 1 shall be equipped with an emergency source of electric power.

(ii) Every passenger vessel navigating in zones 2 and 3 shall be equipped with an emergency source of electric power.

The Administration may prescribe more detailed requirements concerning emergency source of electric power, depending on the type and purpose of the vessel.

9-2.16.2 If a vessel navigating in zones 2 and 3, other than a passenger vessel not less than 25 m in length, is equipped with two or more independent sources of power, one of them may be accepted as an emergency source of power.

9-2.16.3 The emergency source of power may be:

(i) Either an auxiliary set whose fuel supply system and cooling system are independent of the main machinery, and which is automatically started and connected to the network as soon as the voltage falls on the bus-bars of the main switchboard. The electric power shall be supplied within 30 seconds after the failure of the main electricity supply. The Administration or a recognized Classification Society may permit manual starting if the auxiliary set is installed in the immediate vicinity of a station which is permanently manned and which is outside the machinery space;

(ii) Or an accumulator battery automatically taking up current-supply duty in a network failure and capable of meeting the requirements of paragraph 9-2.16.5 for the prescribed time without having to be recharged and without a voltage drop exceeding that authorized. The Administration or a recognized Classification Society may permit manual switching on from a station which is permanently manned and which is outside the machinery space.

On passenger vessels, power for emergency lighting shall be supplied within seven seconds.

9-2.16.4 The emergency source and its switchboard shall be installed:

(i) On vessels navigating in zone 1, above the freeboard deck and outside the machinery space;

(ii) On passenger vessels not less than 25 m in length, navigating in zones 2 and 3, above the freeboard deck, outside the machinery space, the spaces housing the power sources referred to in 9-1.2.1, and the space where the main switchboard is located. The location shall be separated from these spaces by watertight partitions that are fire-resistant according to 15-11.2. If the vessel is less than 25 m in length, the emergency source may be installed in the machinery space, as high up as possible;

(iii) On all other vessels navigating in zones 2 and 3, as high up as possible.

If the space housing the emergency source is situated below the freeboard deck, that space shall be accessible from the deck.

The emergency source of power shall not be installed forward of the collision bulkhead.

9-2.16.5 The capacity of the emergency source shall be sufficient to supply all consumers necessary to the safety of all persons on board, due account being taken of consumers which may

be required to operate simultaneously. At least the following, if their use is prescribed, and if they each have no independent emergency source of power, shall be supplied simultaneously

- (i) Navigation and signal lights;
- (ii) Emergency lighting;
- (iii) Alarm and safety systems;
- (iv) Intercommunication systems;
- (v) Radio and telephone equipment;
- (vi) Emergency floodlight;
- (vii) Controls of fixed fire-fighting installations;
- (viii) Fire pump and emergency pump (on passenger vessels) where the auxiliary set as mentioned in 9-2.16.3 (i) is used;
- (ix) Emergency steering gear;
- (x) The rudder position indicator.

The length of time for which the emergency source of power shall be required to supply the prescribed consumers shall be fixed according to the vessel's purpose, but shall not be less than 30 minutes.

9-2.16.6 At least the following places and stations shall be provided with sufficient emergency lighting:

- (i) Places where collective life-saving appliances are stored, handled and launched;
- (ii) Accommodation exists and passages;
- (iii) Machinery space and its exits;
- (iv) The emergency switchboard;
- (v) The wheelhouse (with provision for disconnection);
- (vi) The space housing the emergency source of power;
- (vii) Fire-fighting stations;
- (viii) Emergency assembly stations for passengers and crew.

The intensity of the emergency lighting shall be prescribed by the Administration.

9-2.17 Alarm and safety systems

The alarm and safety systems for monitoring and protecting mechanical equipment shall meet the following requirements:

9-2.17.1 Alarm systems

The alarm systems shall be so designed that no failure in the alarm system can result in failure of the apparatus or equipment being monitored. Visual alarms shall remain visible until the fault has been remedied; an alarm with acknowledgement shall be distinguishable from an alarm without acknowledgement. Each alarm shall also comprise an audible warning. It shall be possible to switch off acoustic alarms. Switching off one acoustic alarm shall not prevent another signal from being set off by another cause. Exceptions shall be permitted in the case of alarm systems comprising less than 5 measurement points.

9-2.17.2 Safety systems

Safety systems shall be designed to halt or slow down the operation of the affected equipment, or to warn a permanently-manned station to do so before a critical state is reached. Binary transmitters shall be designed according to the load-current principle. If safety systems are not designed to be self-monitoring their operation must be checkable. Safety systems must be independent of other systems.

9-2.18 Electronic equipment9-2.18.1 General

The test conditions in 9-2.18.2 below shall apply only to electronic devices and their ancillaries on the steering system and the vessel's power plants.

9-2.18.2 Test conditions

- (i) The stresses arising from the test shall not cause electronic devices to be damaged or to malfunction. The tests in accordance with the international standards, such as publication IEC 92-504 concerning these, shall be carried out with the device in operation, apart from the cold-proofing test;

- (ii) Variations in voltage and frequency

| | Parameter | Variations | |
|-------------------|-----------|---------------|------------------|
| | | continuous | short-duration |
| General | Frequency | $\pm 5\%$ | $\pm 10\%$ 5 s |
| | Voltage | $\pm 10\%$ | $\pm 20\%$ 1.5 s |
| Battery operation | voltage | + 30% / - 25% | - |

- (iii) Heating test

The sample is brought up to a temperature of 55°C within a half-hour period. After that temperature has been achieved it is maintained for 16 hours. An operating test is then conducted.

- (iv) Cold-condition test

The sample is shut down and cooled to -25°C and held at that temperature for two hours. The temperature is then raised to 0°C and an operating test is conducted.

- (v) Vibration test

The vibration test shall be carried out along the three axes at the resonance frequency of the appliances or parts for the period of 90 minutes in each case. If no clear resonance emerges the vibration test takes place at 30 Hz. The vibration test takes place via sinusoidal oscillation within the following limits:

General:

$$f = 2.0 - 13.2 \text{ Hz}; a = \pm 1 \text{ mm}$$

(amplitude $a = 1/2$ the vibration width)

$$f = 13.2 \text{ Hz} - 100 \text{ Hz}; \text{ acceleration } \pm 0.7 \text{ g.}$$

Equipment intended to be fitted to diesel engines or steering system shall be tested as follows:

$$f = 2.0 - 25 \text{ Hz}; a = \pm 1.6 \text{ mm}$$

(amplitude $a = 1/2$ the vibration width)

$$f = 25 \text{ Hz} - 100 \text{ Hz}; \text{ acceleration } \pm 4g.$$

The sensors intended to be installed in diesel-engine exhaust pipes may be exposed to considerably higher stresses. Account shall be taken of this during the tests.

- (vi) The electromagnetic compatibility test shall be carried out on the basis of IEC publications 801-2, 801-3, 801-4, 801-5 at test degree number 3.
- (vii) Proof that the electronic equipment is adequate for these test conditions shall be provided by their manufacturer. A certificate by a Classification Society is likewise considered to be proof.

9-2.19 Electromagnetic compatibility

The operation of the electric and electromagnetic systems shall not be impaired by electromagnetic interference. General accompanying measures shall concentrate on:

- (i) disconnection of the transmission paths between the source of interference and the user appliances;
- (ii) reducing the causes of disturbance at their source;
- (iii) reducing the sensitivity of the consumer appliances.

CHAPTER 10 EQUIPMENT

10-1 ANCHOR AND MOORING EQUIPMENT

10-1.1 General

10-1.1.1 Vessels shall be provided with anchor equipment according to their type and size and to the waterways on which their use is intended for.

10-1.1.2 Cast iron anchors shall not be permitted.

10-1.1.3 For anchors with increased holding power the Administration may reduce the mass calculated according to 10-1.2 and 10-1.3.

10-1.2 Bow anchors

10-1.2.1 Vessels intended for the carriage of goods, apart from ship-borne barges whose length L does not exceed 40 m, shall be equipped with bow anchors whose total mass P is obtained using the following formula:

$$P = k \cdot B \cdot T \quad [kg]$$

Where k is a coefficient that takes account of the relationship between length L and beam B , and of the type of vessel: for pushed barges, however, $k = c$ will be taken;

$$k = c \sqrt{\frac{L}{8 \cdot B}}$$

c is an empirical coefficient given in the following table:

| Deadweight tonnage in t | Coefficient c |
|-----------------------------|-----------------|
| up to 400 inclusive | 45 |
| from 400 to 650 inclusive | 55 |
| from 650 to 1 000 inclusive | 65 |
| more than 1 000 | 70 |

Passenger vessels and vessels not intended for the carriage of goods including pusher tugs, shall be equipped with bow anchors whose total mass P in kg is calculated according to the formula and the table stated above, using the displacement in cubic meters instead of the deadweight tonnage.

10-1.2.2 For basins where the current velocity does not exceed 6 km/h, the anchor equipment of vessels shall be assigned according to the equipment number N in m^2 calculated according to the formula:

$$N = L_{WL} (B_{WL} + H) + k \sum lh$$

where: k is the coefficient taken equal to 1.0 for vessels for which the total length of superstructures and deckhouses on all decks exceeds half of the vessel's length, and equal to 0.5 for vessels for which the above-mentioned length is within 0.25 to 0.5 of the vessel's length. When the total length of superstructures and deckhouses is less than 0.25 of the vessel's length, superstructures and deckhouses may be dispensed with for the equipment number calculations;

l is the length of individual superstructures and deckhouses in m;

h is the average height of individual superstructures and deckhouses in m.

For vessels intended to carry cargo on deck the value of the parameter $\sum lh$ shall be calculated as the product of the lateral projection length of the cargo stowed on the deck together with cargo limiting structures and its average height, and coefficient k shall be taken as 0.5 for vessels intended to carry only loose cargoes in bulk, and 1.0 for vessels intended to carry other deck cargoes.

The mass of bow anchors P in kg shall be not less than:

- (i) for vessels having the equipment number N up to 1000 m²: $P = KN$;
- (ii) for vessels having the equipment number $N = 1000$ m² and over: $P = KN(1000/N)^{0.2}$,

Where K is the coefficient, generally taken equal to 1.0. However, the Basin administration may assign other value of this coefficient depending on the navigation conditions.

10-1.2.3 Where two bow anchors are provided, their masses shall be equal to each other or differ by not more than 10 per cent.

10-1.3 Stern anchors

10-1.3.1 Vessels shall be equipped with stern anchors whose total mass is equal to 25 per cent of mass P calculated in accordance with 10-1.2.1.

Vessels with a maximum length over 86 meters shall be equipped with stern anchors of total mass equal to 50 per cent of mass P calculated in accordance with 10-1.2.1.

Stern anchors are not required for:

- (i) vessels for which the stern anchor mass will be less than 150 kg;
- (ii) pushed barges.

10-1.3.2 Vessels intended to push convoys not more than 86 m in length shall be equipped with stern anchors whose total mass is equal to 25 per cent of mass P calculated in accordance with 10-1.2.1 for the largest formation (considered to be a nautical unit) permitted and entered in the ship's certificate.

Vessels intended to push rigid convoys that are longer than 86 m downstream shall be equipped with stern anchors whose total mass is equal to 50 per cent of mass P calculated in accordance with 10-1.2.1 for the largest formation (considered to be a nautical unit) permitted and entered in the ship's certificate.

10-1.3.3 For basins where the current velocity is below 6 km/h, the total mass of stern anchors shall be similarly calculated as in 10-1.3.1 and 10-1.3.2, in accordance with the mass P calculated in 10-1.2.2.

10-1.4 Chains and cables

10-1.4.1 Each bow anchor chain shall have a minimum length of:

- 40 m for vessels not exceeding 30 m in length;
- 10 m greater than the vessel's length where the vessel's length is between 30 and 50 m;
- 60 m for vessels more than 50 m in length.

10-1.4.2 Each of the stern anchor chains shall be at least 40 m long. However, where vessels need to stop facing downstream they shall have stern anchor chains that are each at least 60 m in length.

10-1.4.3 Anchor chains shall have a sufficient tensile strength.

10-1.4.4 The use of cables instead of anchor chains is permitted. In this case the cable shall be connected to the anchor by means of a chain with a length sufficient for securing the anchor in its stowed position by means of a chain stopper. The cables shall have the same tensile strength as that required for chains and shall be 20 per cent longer.

10-1.4.5 Vessel shall be equipped with three mooring cables, the minimum lengths of which, in m, shall be as follows:

- First cable: $L + 20$, but not more than 100;
- Second cable: two thirds of the first cable;
- Third cable: one third of the first cable.

On vessel where L is less than 20 m, the third cable shall not be required.

Cables shall be made of steel, natural or synthetic fibre and have a sufficient tensile strength.

10-1.5 Anchor handling and mooring equipment

10-1.5.1 Vessels shall be provided with all necessary fittings and equipment needed for dropping and lifting the anchors, riding at anchor, pulling the vessel to the mooring facilities and its reliable fixing to them. If the mass of an anchor is 50 kg or more, the vessel shall be provided with a windlass or a winch for lifting it.

10-1.5.2 The fittings and their fastenings to the hull shall be strong enough to withstand a pulling load at least equal to the breaking load of the chains or cables for which they are intended.

10-1.5.3 The chain lockers shall be of sufficient capacity to contain the whole of the anchor chain without difficulty.

10-1.5.4 Each anchor chain or cable shall be securely attached at its end to a reinforced part of the hull. The attachment shall incorporate a release device.

10-2 MISCELLANEOUS EQUIPMENT

10-2.1 All manned vessels shall be provided with at least the following equipment:

- The appliances and devices needed for the emission of visual and acoustic signals and for marking the vessel;
- Spare lamps for the navigation lights or an emergency power source for the navigation lights;
- A pair of ship's binoculars;
- A loud-hailer;
- A gangway at least 0.4 m wide and 4 m long, fitted with a hand-rail; the competent authority on inspection of vessels may permit shorter gangways for small vessels;
- A sounding device;
- A boathook;
- A suitable equipment for stopping minor leaks;
- A first-aid kit with content in accordance with a relevant standard of the Administration kept in an accommodation room or in the wheelhouse and stored in such a way that it is easily and safely accessible if necessary. If the first-aid kit is stored concealed the cover shall be marked by a symbol for first-aid kit, having a side length of at least 10 cm;
- A notice concerning the rescue of men overboard;
- Two heaving-lines;
- Radio telephone system.

10-2.2 In addition to the requirements of 10-2.1, manned vessels navigating in zone 2 shall be provided with:

- A fixed compass;
- Availability of nautical charts;
- An echo sounder or a sounding lead.

10-2.3 In addition to the requirements of 10-2.1 and 10-2.2 manned vessels navigating in zone 1 shall be provided with:

- Spare lamps for the navigation lights;
- A radio set for receiving weather reports;
- A chronometer at the steering station;
- A pilot-ladder;
- Covers for windows, skylights and other openings which may let in water.

10-3 FIRE-FIGHTING APPLIANCES

10-3.1. There shall be at least:

- (i) in the wheelhouse: 1 portable fire extinguisher;
- (ii) close to each means of access from the deck to the accommodation: 1 portable fire extinguisher;
- (iii) close to each means of access to service premises that are not accessible from the accommodation, and which contain heating, cooking or refrigerating equipment using solid or liquid fuels or liquefied gas: 1 portable fire extinguisher;
- (iv) at each entrance to the engine room and boiler rooms: 1 portable fire extinguisher;
- (v) at suitable points below deck in engine rooms and boiler rooms such that no position in the space is more than 10 metres walking distance away from an extinguisher: 1 portable fire extinguisher.

10-3.2. The extinguishers shall be suitable for their purpose and shall meet the requirements of the Administration or recognized Classification Society. They shall be inspected and checked at least once every two years. A certificate to that effect, signed by the firm or person that carried out the inspection, shall be kept on board.

10-3.3. The extinguishing substance may neither be halon nor contain a product which is likely to release toxic gases, such as carbon tetrachloride during use. Portable fire extinguishers using CO_2 may only be used to fight fires at specific locations such as electrical installations, kitchens; the quantity of CO_2 shall not constitute a health hazard.

10-3.4. Extinguishers sensitive to frost or heat shall be installed or protected in such a manner that they are always ready for use.

10-3.5. If the fire-fighting appliances are so installed as to be concealed from view, the plates or doors concealing them shall bear a symbol corresponding to relevant sketches of appendix 3 with a side length of at least 10 cm.

10-3.6. Fixed fire-extinguishing installations shall meet the requirements of the Administration or of a recognized Classification Society. The use of halon is not authorized. The equipment shall be checked at least every two years by an approved expert. The dated inspection certificates, signed by the inspector involved, shall be kept on board.

10-3.7. In addition to the above provisions of this chapter, all vessels intended for navigation in zone 1 shall be provided with fire pumps, pressure piping for fire-extinguishing water, and fire hydrants and hoses. The equipment shall meet the requirements of the Administration or recognized Classification Society.

10-3.8. In addition to the above provisions of this chapter, vessels with a length of 110 m or more and intended for navigating in zone 1 shall have a fixed fire-extinguishing installation installed in:

- (i) rooms in which main or auxiliary oil-fired boilers are installed and rooms containing fuel pumps or settling tanks;
- (ii) rooms containing internal combustion engines constituting the main means of

propulsion or used as auxiliary machinery with the installed total capacity of not less than 750 kW.

10-4 HOISTING GEAR, RIGGING AND EQUIPMENT

10-4.1 Masts fitted with hoisting gear

10-4.1.1 Masts for supporting derricks shall be made of standardized material or materials approved by a recognized Classification Society.

10-4.1.2 The masts shall be suitably fixed to the vessel and shall be built to adequate scantlings, account being taken of the maximum load on the derricks they are intended to support.

10-4.2 Derricks and other hoisting gear

10-4.2.1 Hoisting gear (including masts and derricks) and all fixed or movable fittings used on board for loading or unloading shall comply with the requirements of the Convention concerning Occupational Safety and Health in Dock Work 1979 (Convention No. 152) adopted by the International Labour Office.

10-4.2.2 Hoisting gear other than mentioned in 10-4.2.1 shall meet the requirements of the Administration.

10-5 LIFE-SAVING APPLIANCES

10-5.1 Collective life-saving appliances

10-5.1.1 General requirements

10-5.1.1.1 Collective life-saving appliances shall:

- (i) carry an indication of the use and of the number of persons for which they are approved;
- (ii) have and maintain a stable trim if grabbed by the indicated number of persons;
- (iii) be fitted with a line securely fastened round the outside perimeter enabling them to be grabbed by persons being in water;
- (iv) be made of a suitable material and be resistant to oil and oil products, and to temperatures of up to 50°C;
- (v) have a fluorescent orange colour or have permanently fixed fluorescent surfaces measuring at least 100 cm²;
- (vi) be rapidly and safely launchable from their place of storage by a single person;
- (vii) be checked in accordance with manufacturer's instructions.

10-5.1.1.2 Inflatable life-saving appliances shall in addition to 10-5.1.1.1:

- (i) comprise at least two separate air compartments;
- (ii) inflate automatically or by manual command when launched;
- (iii) have and maintain a stable trim whatever load it is supporting, even with only half of the air compartments inflated;
- (iv) be checked in accordance with the manufacturer's instructions.

10-5.1.2 Lifeboats

10-5.1.2.1 All lifeboats shall be well designed and of such shape and proportions that they have ample stability and sufficient freeboard when carrying their full load of persons and equipment.

10-5.1.2.2 All lifeboats shall be strong enough to be lowered into the water with complete safety when carrying their full load of persons and equipment. They shall be of such strength that they will not suffer permanent deformation if subjected to an overload of 25%.

10-5.1.2.3 Every lifeboat shall meet the following requirements:

- (i) it shall be equipped with seats sufficient for at least three persons;
- (ii) the number of persons whom the lifeboat is permitted to carry shall be determined according to its cubic capacity as calculated by the recognized methods, on the basis of not less than 0.225 m³ per person. The seating capacity of the lifeboat shall be determined by tests to find out how many adults wearing lifejackets can be accommodated without interfering with the rowing and steering of the lifeboat;
- (iii) the lifeboat stability shall be adequate for the maximum number of persons it may carry; its stability shall be deemed to be adequate if, with half the maximum permissible number of persons seated on one side of the lifeboat, there remains a freeboard of not less than 100 mm;
- (iv) there shall be a seat width of not less than 0.45 m per person;
- (v) the lifeboat shall remain sufficiently buoyant and sufficiently stable when carrying its full load of persons and equipment and filled with water.

10-5.1.2.4 The lifeboat equipment shall meet the requirements of the Basin administration or a recognized Classification Society.

10-5.1.3 Liferafts

10-5.1.3.1 Every liferaft shall be fitted with devices for mooring and towing.

10-5.1.3.2 Every liferaft shall be so constructed as to comprise units containing a volume of air of at least 0.096 m³ (or equivalent buoyancy devices in the case of rigid liferafts), and a deck area of at least 0.372 m², for every person it is permitted to carry.

10-5.1.3.3 The liferaft shall be so constructed that if it is dropped into the water from a height of 10 metres, neither the liferaft nor its equipment will be damaged.

10-5.1.3.4 Liferaft equipment shall comply with the requirements of the Basin administration or a recognized Classification Society.

10-5.1.3.5 Inflatable liferafts are in addition to paragraphs 10-5.1.3.1 - 10-5.1.3.4 to meet the following requirements:

- (i) every inflatable liferaft shall be so designed that, when fully inflated and floating, it is stable in the water;
- (ii) the liferaft shall be capable of being easily righted by one person in the water if it inflates upside down;
- (iii) the liferaft shall be fitted with appropriate means of enabling persons in the water to climb on board;

- (iv) the liferaft shall be packed in a valise or container capable of withstanding hard wear and use; the liferaft in its valise or container shall float in such a way as to permit the immediate operation of the inflation system.

10-5.1.3.6 Rigid liferafts shall in addition to paragraphs 10-5.1.3.1 - 10-5.1.3.4 meet the following requirements:

- (i) rigid liferaft shall be so constructed as to retain its shape in all weather conditions, on deck and in the water;
- (ii) the deck area of the liferaft shall be situated within that part of the liferaft which affords protection to its occupants. The nature of the deck shall be such as to prevent so far as practicable the ingress of water and it shall effectively hold the occupants out of the water;
- (iii) the equipment of the liferaft shall be so stowed as to be readily accessible whichever way up the liferaft is floating.

10-5.1.4 Ship's boats

10-5.1.4.1 Ship's boats may be used as a collective life-saving appliance if complying with the requirements of 10-5.1.1.

10-5.1.4.2 The ship's boats shall meet the following requirements:

- (i) they shall be easy to steer and manoeuvre, they shall maintain their course and not drift significantly under the effect of the wind, the current or the waves;
- (ii) they shall have seats for at least three persons;
- (iii) they shall be sufficiently resistant;
- (iv) their volume shall be at least 1.5 m^3 , or the product of $L_C \times B_C \times H_C$ shall represent at least 2.7 m^3 ;
- (v) their freeboard shall be at least 25 cm with three persons of approximately 75 kg each on board;
- (vi) they shall be adequately stable. This shall be considered adequate if there is a residual freeboard of at least 10 cm when two persons of roughly 75 kg each are on one side as close as possible to the gunwale;
- (vii) their buoyancy in N with no passengers on board, but completely filled with water, shall be at least equal to $300 \times L_C \times B_C \times H_C$;
- (viii) the following gear shall be on board:
 - one set of oars;
 - one mooring rope;
 - one bailer.

10-5.1.4.3 It shall be possible for one person to launch such ship's boats safely. If a power-driven unit is used for launching it should be ensured that a failure of the power supply will not jeopardize rapid and safe launching.

10-5.1.4.4 Inflatable ship's boats shall be permitted provided the conditions set out in paragraphs 10-5.1.4.2 and 10-5.1.4.3 are met, that they are permanently operational and that they have several compartments.

10-5.1.4.5 If a ship's boat is used on a passenger vessel as a lifeboat it shall at least meet the conditions set out in paragraph 10-5.1.4.2. However,

- (i) seat width shall be at least 0.45 m per person, while the maximum permissible number of persons shall not exceed the product of $3 \times L_C \times B_C \times H_C$;
- (ii) their stability shall be considered adequate if there is a freeboard of at least 10 cm when half of the maximum number of passengers permitted are positioned on one side of the ship's boat.

Note: In paragraphs 10-5.1.4.2 and 10-5.1.4.5:

L_C is the ship's boat length in metres;

B_C is the ship's boat width in metres;

H_C is the ship's boat depth in metres.

10-5.1.5 Life-saving buoyancy aids

Life-saving buoyancy aids shall provide a buoyancy of at least 100 N (Newton) per person in fresh water.

10-5.2 Individual life-saving appliances

10-5.2.1 General requirements

Individual life-saving appliances shall meet the following requirements:

- (i) to provide a buoyancy of at least 100 N in fresh water;
- (ii) to be made of a suitable material and be resistant to oil and oil products, and to temperatures of up to 50°C;
- (iii) have a fluorescent orange colour or have permanently fixed fluorescent surfaces measuring at least 100 cm²;
- (iv) to be capable of supporting an iron load of 7.5 kg in fresh water for 24 hours.

10-5.2.2 Lifejackets

10-5.2.2.1 A lifejacket shall satisfy the following requirements:

- (i) it shall be capable of keeping the head of an exhausted or unconscious person above water;
- (ii) it shall be so designed as to eliminate so far as possible all risk of its being put on incorrectly; however, it shall be capable of being worn inside out;
- (iii) it shall be capable of turning the wearer's body, on entering the water, to a safe floating position slightly inclined backwards from the vertical;
- (iv) it shall be easy and quick to put on, and shall fasten securely to the body;

10-5.2.2.2 Inflatable life jackets shall inflate automatically and manually and may also be inflated by mouth. They shall be checked in accordance with the manufacturer's instructions.

10-5.2.2.3 Inflatable lifejackets shall meet the requirements of the Basin administration.

10-5.2.3 Lifebuoys

10-5.2.3.1 Lifebuoys shall meet the following requirements:

- (i) have a mass of not less than 2.5 kg;
- (ii) have an internal diameter of 0.45 m \pm 10%;
- (iii) be encircled with rope which can be grasped.

10-5.2.3.2 At least one lifebuoy on each side of the vessel shall be fitted with a reliably secured buoyant lifeline which is not less than 25 m long.

10-5.3 Stowage and handling of life-saving appliances

10-5.3.1 Life-saving appliances shall be stored on board in such a way that in case of need it can be easily and safely reached. Concealed storage places shall be clearly signed.

10-5.3.2 The lifeboat launching devices - davits, falls, blocks and other gear - shall be of such strength that the lifeboats can be safely lowered on either side in unfavourable conditions of list or trim.

10-5.3.3 All collective life-saving appliances shall be so stowed that they can be launched as quickly as possible.

10-5.3.4 The lifebuoys shall be ready for use and located on deck at suitable places, but shall not be fastened into their holders. At least one lifebuoy shall be placed in the immediate vicinity of the wheelhouse.

10-5.3.5 Where necessary, equipment should be provided to pull launchable collective life-saving appliances towards the side of the vessel and restrain them in that position to facilitate safe embarkation.

10-5.4 Number and capacity of life-saving appliances

10-5.4.1 General

In general, all vessels shall be provided with life-saving appliances appropriate to the navigation zone, as specified below.

10-5.4.2 Vessels navigating in zone 1

10-5.4.2.1 Vessels navigating in zone 1 shall have:

- (i) - either on each side of the vessel, one or more lifeboats of sufficient aggregate capacity to accommodate all persons on board;
 - or one or more lifeboats capable of being launched on either side of the vessel and of sufficient aggregate capacity to accommodate all persons on board;
 - or ship's boat and, on each side of the vessel, one or more liferafts of sufficient aggregate capacity to accommodate all persons on board;
- (ii) one or more liferafts of sufficient aggregate capacity to accommodate half the total number of persons on board;
- (iii) a sufficient number of lifejackets for all persons on board;

- (iv) at least four lifebuoys, of which at least two shall be equipped with a source of light if the vessel travels at night.

10-5.4.2.2 Vessels navigating in zone 1 need not be equipped with liferafts provided that they are equipped with lifeboats in accordance with paragraph 10-5.4.2.1, subparagraph (i), first item above.

10-5.4.3 Vessels navigating in zones 2 and 3

Vessels navigating in zones 2 and 3 shall have:

- (i) collective life-saving appliances conforming in number and capacity to the requirements of the Basin administration or a recognized Classification Society;
- (ii) a sufficient number of lifejackets for all persons on board;
- (iii) at least three lifebuoys for smaller vessels, although two lifebuoys may be allowed by the Basin administration. At least one of these buoys shall be equipped with a source of light if the vessel travels at night.

These provisions shall not apply to unmanned vessels such as pushed barges.

10-5.5 Carriage of ship's boats

The following vessels shall carry a ship's boat:

- (i) self-propelled vessels and manned towed barges of more than 150 tonne dwt;
- (ii) tugs and pushers of more than 150 m³ displacement;
- (iii) floating equipment;
- (iv) passenger vessels.

CHAPTER 11 WORKING SPACES

11-1 GENERAL

11-1.1 Vessels shall be built, arranged and equipped in such a way as to enable the crew to work and move about safely.

11-1.2 The necessary on-board working facilities including permanent fixtures shall be arranged, laid out and protected in such a way as to permit safe, easy movement on board, and maintenance. If necessary, moving parts of machinery and hot parts of installations shall be provided with the means to protect people.

11-2 PROTECTION AGAINST FALLING

11-2.1 Decks including side decks and wherever people walk and work shall be free from obstacles likely to cause tripping and it shall be impossible for puddles to remain.

11-2.2 Decks including side decks, engine-room floors, landings, companionway steps and the tops of bollards shall be designed to prevent slipping.

11-2.3 The tops of side deck bollards and obstacles in passageways, such as the edges of steps, shall be painted in a colour contrasting with the surrounding decks.

11-2.4 The outer edges of decks, as well as working spaces where people might fall more than 1 metre, shall be fitted with bulwarks or coamings or with a guard rail, which shall comprise a handrail at least 0.90 m high, a rail at knee height and a foot-rail. Coamings may be fitted with a hand-rail only. Coaming hand-rails shall not be required where side decks are fitted with non-retractable guard rails.

11-3 DIMENSIONS OF WORKING SPACES

Working spaces shall be large enough to provide every person working in them with adequate freedom of movement.

11-4 SIDE DECK

11-4.1 The clear width of the side deck shall be at least 0.60 m. That figure may be reduced to 0.5 m at certain positions where necessary installations are located such as deck-swabbing cocks and to 0.4 m at bollard emplacements.

11-4.2 Up to a clear height of 0.90 m above the side deck, the clear width of the side deck may be reduced to 0.54 m provided that the clear width above, between the outer edge of the hull and the inner edge of the hold, is not less than 0.65 m. However, the clear width of the side deck may be reduced to 0.50 m if the outer edge of the side deck is fitted with a guard rail in accordance with paragraph 11-2.4 to prevent falling. On vessels of 55 m or less in length the guard rail may be dispensed with provided that the safety conditions are deemed satisfactory by the Administration.

11-4.3 The requirements of 11-4.1 and 11-4.2 shall apply up to a height of 2.00 m above the side deck.

11-5 ACCESS TO WORKING SPACES

11-5.1 Points of access and passageways for the movement of people and objects shall be of sufficient size and so arranged that:

- (i) in front of the access opening, there is sufficient room not to impede movement;
- (ii) the clear width of the passageway shall be appropriate for the intended use of the working space and shall be not less than 0.60 m, except in the case of vessels less than 8 m wide, where it may be reduced to 0.50 m;
- (iii) the height of the access opening including the coaming, if any, is not less than 1.90 m.

11-5.2 Doors shall be so arranged that they can be opened and closed safely from both sides. They shall be protected against accidental opening or closing.

11-5.3 Stairs, ladders or steps shall be installed in accesses, exits and passageways where there is more than a 0.50 m difference in floor level.

11-5.4 Working spaces which are manned continuously shall be fitted with stairs if there is a difference in floor level of more than 1 m. This requirement shall not apply to emergency exits.

11-5.5 Vessels equipped with holds shall have at least one fixed ladder in each hold which can be used to enter and leave the hold safely. This requirement shall not apply where two movable hold ladders are provided.

11-6 EXITS AND EMERGENCY EXITS

11-6.1 The number, arrangement and dimensions of exits, including emergency exits, shall be in accordance with the use and dimensions of the relevant space. Where one of the exits is an emergency exit, it shall be clearly marked as such.

11-6.2 Emergency exits or windows, portholes or skylights serving as emergency exits shall have a clear opening of not less than 0.36 m², and the smallest dimension shall be not less than 0.50 m.

11-7 STAIRS, LADDERS AND STEPS

11-7.1 Stairs and fixed ladders shall be securely attached to the vessel structures.

11-7.2 Stairs shall be not less than 0.60 m wide; steps shall be not less than 0.15 m deep and not more than 0.3 m high; steps shall have non-slip surfaces and stairs with more than three steps shall be fitted with hand-rails. The clear width between hand-rails shall be not less than 0.60 m.

11-7.3 Fixed ladders and climbing steps shall have a clear width of not less than 0.30 m; step height shall be not more than 0.30 m and the distance from the centre of the step to the vessel structures shall be not less than 0.15 m.

11-7.4 Fixed ladders and climbing steps shall be clearly identifiable as such from above and shall be equipped with safety handles above exit openings.

11-7.5 Portable ladders shall be at least 0.40 m wide, and at least 0.50 m wide at the base; it shall be possible to ensure that they will not topple or skid; the rungs shall be securely fixed in the uprights.

11-7.6 Portable ladders used as hold ladders shall, with a 60° incline, extend to at least 1 m above the deck and in any event above the upper edge of the hatchway coaming.

11-8 INSIDE SPACES

11-8.1 The dimensions, arrangement and layout of inside working spaces shall be in accordance with the work to be carried out and shall meet the national health and safety requirements of the Administration. They shall be equipped with adequate non-dazzle lighting and with ventilation arrangements; if necessary, they shall be fitted with heating appliances capable of maintaining an adequate temperature.

11-8.2 The floors of inside working spaces shall be solid and durable, and shall be designed not to cause tripping or slipping. Windows, portholes and skylights shall be so arranged and fitted that they can be operated and cleaned safely.

11-8.3 The light switches for the working spaces shall be installed in readily accessible positions near doors.

11-9 PROTECTION AGAINST NOISE AND VIBRATION

11-9.1 Working spaces shall be so situated, equipped and designed that crew members are not exposed to harmful vibrations.

11-9.2 Permanent working spaces shall be so constructed and soundproofed that the health and safety of crew members are not adversely affected by excessive noise.

11-9.3 Spaces and areas in which people are continuously exposed to noise levels that exceed 85 dB(A) should be marked with signs "Use ear protectors" in accordance with sketch 7 of appendix 3 with diameter of at least 10 cm and people who work in them should use individual acoustic protection devices.

11-9.4 The maximum permissible sound pressure level in the engine rooms shall be 110 dB(A). The measuring points shall be selected as a function of the maintenance work needed during normal operation of the plant located therein.

11-10 HATCH COVERS

11-10.1 Hatch covers shall be easily accessible and safe to handle. Hatch-cover components weighing more than 40 kg shall be designed to slide or pivot or be fitted with mechanical opening devices. Hatch covers operated by lifting gear shall be fitted with easily accessible attachment devices. Non-interchangeable hatch covers and hatch beams shall be clearly marked to show the hatches to which they belong and their correct positions on those hatches.

11-10.2 Hatch covers shall have provision for being firmly secured in their working position. Sliding covers shall be capable of being locked in their final positions; they shall be fitted with catches to prevent accidental horizontal movement of more than 0.40 m in any other position. Appropriate devices shall be fitted to hold stacked hatch covers in position.

11-10.3 The power supply for mechanically operated hatch covers must be cut off automatically when the control switch is released.

11-10.4 Hatch covers must be capable of bearing the loads to which they are likely to be subjected: if less than 12 people, each assumed to weigh 75 kg, can be supported on a load-supporting hatch cover, a notice stating the number of persons that such a hatch cover can support shall be prominently displayed. Hatch covers designed to receive deck cargo shall have the permissible load in t/m² marked on them. Where braces are needed to support the maximum permissible load this shall be indicated in an appropriate place, in which case the relevant drawings shall be kept on board.

11- 11 WINCHES

11-11.1 Winches shall be designed in such a way as to enable work to be carried out safely. They shall be fitted with devices that prevent unintentional load release. Winches that do not lock automatically shall be fitted with a brake that is adequate to deal with their tractive force.

11-11.2 Hand-operated winches shall be fitted with devices to prevent kick-back of the crank. Winches that are both power driven and hand-operated shall be designed in such a way that the motive-power control cannot actuate the hand-operated control.

CHAPTER 12

CREW ACCOMMODATION

12-1 GENERAL

12-1.1 Vessels shall have accommodation for the persons lodging habitually on board, and at least for the minimum crew.

12-1.2 Accommodation shall be so designed, arranged and fitted out as to meet the health, safety and comfort needs of those on board. It shall be of safe and easy access and insulated against heat and cold. Where there is no deck-level access to the accommodation and the difference in level is 0.30 m or more the accommodation shall be accessible by means of companionways. In the fore section of the vessel no floor shall be more than 1.20 m below the plane of maximum draught.

12-1.3 The competent authority may authorize derogations to the prescriptions of this chapter if the health and safety of those on board are ensured by other means. The competent authority shall indicate on the ship's certificate any restrictions to the vessel's operating mode/entry into service resulting from the derogations.

12-2 SPECIAL DESIGN REQUIREMENTS

12-2.1 Location and condition

12-2.1.1 No accommodation shall be located ahead of the plane of the collision bulkhead.

12-2.1.2 The accommodation shall be separated from engine- and boiler rooms by gastight bulkheads and from the holds by watertight bulkheads that extend up to the deck.

12-2.1.3 The accommodation shall be directly accessible from the deck.

12-2.1.4 The accommodation complex shall have at least one day-room partitioned off from the sleeping quarters.

12-2.1.5 The accommodation shall be so designed and arranged as to prevent as far as possible the penetration of foul air from other areas of the vessel such as engine rooms or holds; where forced-air ventilation is used the intake vents shall be so placed as to satisfy the above requirements. The exhaust air from galleys or spaces equipped with sanitary installations shall be expelled directly from the vessel.

12-2.1.6 It shall be possible to heat accommodation in accordance with its intended use. Heating installations shall be appropriate for the weather conditions which may arise.

12-2.1.7 It shall be possible to ventilate the accommodation adequately.

12-2.1.8 Accommodation shall be protected against noise and vibration. Sound pressure levels shall not exceed:

- (i) 70 dB(A) in the living quarters;
- (ii) 60 dB(A) in the sleeping quarters. This provision does not apply to vessels operating exclusively no more than 14 hours per day. The operating mode restriction shall be mentioned on the certificate.

12-2.1.9 The accommodation shall be provided with emergency exits permitting rapid evacuation. Exits of living and sleeping quarters shall comply with the requirements of article 12-1.2.

12-2.1.10 Pipes carrying dangerous gases or liquids, or which are subjected to such high internal pressure in which the slightest leak could pose a danger to human beings, shall not be located in the accommodation or in corridors leading to the accommodation. An exception to this rule is made for and hydraulic system pipes, provided they are fitted in metal casings, and for the pipes of liquefied gas installations for domestic purposes.

12-2.2 Dimensions of the accommodation

12-2.2.1 The clear headroom in the accommodation shall be not less than 2.00 m.

12-2.2.2 The free floor area of the living quarters shall be not less than 2 m² per person, and in any event not less than 8m² in total (not counting furniture, except tables and chairs).

12-2.2.3 The volume of air per person shall be at least 3.5 m³ in living quarters. In the sleeping quarters, it shall be at least 5 m³ for the first occupant and at least 3 m³ for each additional occupant (not counting the volume of furniture). Sleeping cabins shall, as far as possible, be intended for no more than two persons.

12-2.2.4 The cubic capacity of each unit in the living and sleeping quarters shall be not less than 7 m³.

12-3 APPROACHES, DOORS AND STAIRWAYS

12-3.1 Doors shall have a total height, coamings included, of at least 1.90 m and a clear width of at least 0.60 m. The prescribed height may be achieved by means of sliding or hinged covers or flaps. It shall be possible to open doors from either side. Coamings shall be not more than 0.40 m high, but shall nonetheless comply with the provisions of other safety regulations.

12-3.2 Companionways shall be permanently fixed and safely negotiable. They shall be deemed to be so when they are constructed according to the requirements of section 11-7.

12-4 DAYLIGHT AND LIGHTING

12-4.1 The accommodation shall be adequately lighted. The living quarters, galleys and, if possible, the other compartments shall be accessible to daylight.

12-4.2 Standards of natural and artificial illumination shall be fixed by the Administration.

12-5 FITTINGS

12-5.1 Each crew member living on board shall be provided with an individual berth and an individual clothes locker fitted with a lock. The internal measurements of the berth shall be not less than 2.00 x 0.90 m. The height of the locker shall be not less than 1.7 m and the available horizontal area not be less than 0.25 m².

12-5.2 Berths shall be not less than 0.30 m above the floor. Where one berth is placed over another, the clear headroom above each berth shall be not less than 0.60 m. Berths shall not be arranged in tiers of more than two.

12-5.3 Suitable places for storing and drying work clothes shall be provided, but not in the sleeping quarters.

12-6 GALLEYS AND DAY-ROOMS (MESSROOMS)

12-6.1 Galleys shall comprise:

- (i) a cooker;
- (ii) a sink with waste connection;
- (iii) a supply of potable water;
- (iv) refrigerator;
- (v) sufficient storage and working space.

12-6.2 Galleys may be combined with day-rooms.

12-6.3 Manned vessels shall have a refrigerator and where necessary cold storerooms. The doors of cold storerooms that are large enough to admit a person must be fitted with locks that can be opened from both sides.

12-6.4 The eating area of combined galleys/day-rooms shall be large enough to accommodate the number of crew normally using it at the same time. Seats shall be not less than 0.60 m wide.

12-7 SANITARY INSTALLATIONS

12-7.1 The following sanitary installations at least shall be provided in vessels with accommodation:

- (i) one toilet per accommodation unit or per six crew members, which it shall be possible to ventilate with fresh air;
- (ii) one wash basin with waste pipe and hot and cold taps connected to a source of potable water per accommodation unit or per four crew members;
- (iii) one shower or bath connected up to hot and cold potable water per accommodation unit or per six crew members.

12-7.2 The sanitary installations shall be in close proximity to the accommodation. Toilets shall not have direct access to galleys, mess rooms or combined day-rooms/galleys.

12-7.3 Toilet compartments shall have a floor space of at least 1 m², not less than 0.75 m wide and not less than 1.10 m long. Toilet compartments in cabins for no more than two persons may be smaller. Where a toilet contains a wash basin and/or shower, the surface area shall be increased at least by the surface area occupied by the wash basin and/or shower (or bath).

12-8 POTABLE-WATER INSTALLATIONS

12-8.1 Vessels with accommodation shall have one or more potable water tanks. Potable water tank filling apertures and potable water pipes shall be marked as being intended exclusively for potable water. Potable water filler necks shall be installed above the deck.

12-8.2 Potable water tanks shall:

- (i) be protected against excessive heating;
- (ii) have a capacity as prescribed by the Basin administration;
- (iii) be made of a material which resists corrosion and poses no physiological danger;
- (iv) have a suitable, lockable opening to enable the inside to be cleaned;
- (v) have a water level indicator;
- (vi) have ventilation caps to the open air or which are fitted with appropriate filters.

12-8.3 Potable water tanks shall not share walls with other tanks. Potable water pipes shall not pass through tanks containing other liquids. Connections are not permitted between the potable water supply system and other pipes. Pipes carrying gas or liquids other than potable water shall not pass through potable water tanks.

12-8.4 Potable water pressure vessels shall operate only on uncontaminated compressed air. Where it is produced by means of compressors, appropriate air filters and oil separators shall be installed directly in front of the pressure vessel unless the water and the air are separated by a diaphragm.

CHAPTER 13

FUEL-FIRED HEATING, COOKING AND REFRIGERATING EQUIPMENT

(Left void)

CHAPTER 14

LIQUIFIED GAS INSTALLATIONS FOR DOMESTIC PURPOSES

14-1 GENERAL

14-1.1 Every gas installation shall consist essentially of one or more gas receptacles, one or more pressure reducers, a distribution system and a number of gas-consuming appliances.

14-1.2 Such installations may be operated only with the gas mixture of which the customary name is propane.

14-2 INSTALLATION

14-2.1 Gas installations shall, in all their parts, be suitable for the use of propane and shall be built and installed in accordance with the state of the art.

14-2.2 A gas installation may be used only for domestic purposes in spaces that comply with the requirements of the Administration.

14-2.3 There may be several separate gas installations on board. Accommodation areas separated by a cargo hold or a fixed tank shall not be supplied by the same installation.

14-2.4 Installations which are not permanently fixed may be used only if they meet the special requirements laid down by the Administration.

14-3 RECEPTACLES

14-3.1 Only receptacles with a capacity of between 5 and 35 kg shall be allowed. In the case of passenger vessels, the Basin administration may approve the use of receptacles with a larger content.

14-3.2 The receptacles shall satisfy the requirements in force. They shall bear the official stamp certifying that they have passed the statutory tests.

14-4 LOCATION AND ARRANGEMENT OF THE SUPPLY UNIT

14-4.1 The supply unit shall be installed on deck in a special cupboard located outside the accommodation area in such a position that it does not interfere with movement on board. It shall not, however, be installed against the forward or after bulwark plating. The cupboard may be a wall cupboard set into the superstructure provided that it is gastight to that superstructure and can only be opened to the outside. It shall be so located that the pipes leading to the gas consumption points are as short as possible.

Each installation may have up to four receptacles in operation simultaneously, with or without the use of an automatic changeover valve. The number of receptacles on board, including spare receptacles, shall not exceed six per installation.

On passenger vessels having galleys or canteens for the passengers, up to six receptacles per installation may be in operation simultaneously, with or without the use of an automatic changeover valve. The number of receptacles on board such vessels, including spare receptacles, shall not exceed nine per installation.

The pressure reducer or, in the case of two-stage reduction, the first pressure reducer shall be fitted to the inside wall of the cupboard for the receptacles.

14-4.2 The supply unit shall be so installed that any leaking gas can escape from the cupboard without any risk that it may penetrate the vessel or come into contact with any possible source of ignition.

14-4.3 The cupboard shall be constructed of fire-resistant materials and shall be adequately ventilated by openings at the top and bottom. The cupboard shall be fitted with a locking device preventing unauthorized persons from gaining access to the receptacles. The receptacles shall be placed upright in the cupboard in such a way that they cannot overturn.

14-4.4 The cupboard shall be so constructed and situated that the temperature of the receptacles cannot exceed 50°C.

14-4.5 The words “liquefied gas” and “no naked lights or fires and no smoking” symbol at least 100 mm in diameter in accordance with sketch 2 of appendix 3 shall be affixed to the outer wall of the cupboard.

14-5 SPARE AND EMPTY RECEPTACLES

Spare and empty receptacles which are not stored in the supply unit shall be stored outside the accommodation area, and the wheelhouse in a cupboard, constructed in accordance with the requirements of section 14-4, paragraphs 14-4.2 to 14-4.5.

14-6 PRESSURE REDUCERS

14-6.1 The gas-consuming appliances may be connected to the receptacles only through a distribution system fitted with one or more pressure reducers to bring the gas pressure down to the working pressure. The pressure may be reduced in one or two stages. All pressure reducers shall be set permanently at a pressure determined in accordance with section 14-7 below.

14-6.2 The final pressure reducer shall be either fitted with or followed by a device to protect the piping automatically against excess pressure in the event of a malfunction of the pressure reducer. Any gas which this protection device allows to escape shall be evacuated into the open air without any risk that it may penetrate the vessel or come into contact with any possible source of ignition; if necessary a special vent shall be fitted for this purpose.

14-6.3 The safety devices and the vents shall be protected against ingress of water.

14-7 PRESSURE

14-7.1 The pressure at the outlet of the final pressure reducer shall not be more than 5 kPa above atmospheric pressure, with a tolerance of 10%.

14-7.2 In the case of two-stage reduction, the intermediate pressure shall not be more than 250 kPa above atmospheric pressure.

14-8 PIPING AND FLEXIBLE TUBES

14-8.1 The piping shall consist of fixed steel or copper tubing.

The pipes connected to the receptacles, however, shall consist of high pressure flexible tubing or spiral tubes suitable for the gas used. The gas consuming appliances may, if they are not installed as fixtures, be connected up by means of suitable flexible tubes not more than 1 m long.

14-8.2 The piping shall be able to withstand all influences to which it may be subjected under normal operating conditions on board, in particular corrosion and stresses, and its characteristics and layout shall be such that it ensures a satisfactory flow of gas at the appropriate pressure to the gas consuming appliances.

14-8.3 The piping shall include as few joints as possible. The piping and the joints shall be gastight and shall remain gastight despite any vibration or expansion to which they may be subjected.

14-8.4 The piping shall be readily accessible, properly fixed and protected at every point where it might be subjected to impact or friction, particularly where it passes through metal bulkheads or other metal partitions.

The entire outer surface of steel piping shall be treated against corrosion.

14-8.5 Flexible pipes and their joints shall be able to withstand any stresses which may occur under normal operating conditions on board. They shall be fitted without load and in such a way that they cannot be overheated and can be inspected throughout their length.

14-9 DISTRIBUTION SYSTEM

14-9.1 No part of a gas installation shall be situated in the machinery space.

14-9.2 It shall be possible to shut off the entire distribution system by means of a valve which is readily and quickly accessible.

14-9.3 Each gas-consuming appliance shall be supplied by a separate branch of the distribution system, and each such branch shall be controlled by a separate closing device.

14-9.4 The valves shall so far as possible be protected from the weather and against impact.

14-9.5 The ends of pipes intended for connection to gas-consuming appliances shall be closable by a flange or cap even if they are equipped with a shut-off valve.

14-9.6 An inspection joint shall be fitted after each pressure reducer. It shall be ensured, using a closing device, that in pressure tests the pressure reducer is not exposed to the test pressure.

14-10 GAS-CONSUMING APPLIANCES AND THEIR INSTALLATION

14-10.1 The only consuming appliances that may be installed shall be those which have been approved by the Administration and which are equipped with devices that effectively prevent the escape of gas in case of extinction either of the burner or of the pilot flame.

14-10.2 Each appliance shall be so placed and connected as to avoid any risk that the connecting piping may be accidentally wrenched loose.

14-10.3 The installation of gas-consuming appliances in the wheelhouse shall be permitted only if the wheelhouse is so constructed that no leaking gas can escape into the lower parts of the vessel.

14-10.4 Gas-consuming appliances may be installed in sleeping rooms only if the combustion process does not depend on the ambient air.

14-10.5 Gas-consuming appliances in which the combustion process depends on the ambient air shall be installed only in rooms of sufficient size.

14-11 VENTILATION AND EVACUATION OF THE COMBUSTION GASES

14-11.1 Heating and water-heating appliances and refrigerators shall be connected to a duct for evacuating combustion gases into the open air.

14-11.2 In spaces containing gas-consuming appliances in which the combustion process depends on the ambient air, the supply of fresh air and the evacuation of the combustion gases shall be ensured by means of apertures of adequate dimensions determined according to the capacity of the appliances, with a clear section of at least 150 cm² per aperture.

14-11.3 The ventilation apertures shall not have any closing device and shall not lead into sleeping rooms.

14-11.4 The evacuation devices shall be such as to ensure reliable and effective evacuation of the combustion gases. They shall be non-combustible and their effectiveness shall not be impaired by the room ventilators.

14-12 INSTRUCTIONS FOR USE AND SAFETY

A notice containing instructions on the use of the installation shall be affixed on board in a suitable place. The notice shall bear, in particular, the following instructions:

“The valves of receptacles which are not connected to the distribution system shall be closed even if the receptacles are presumed to be empty.”

“Flexible pipes shall be renewed as soon as their condition so requires.”

“All receptacles shall be kept connected up unless the corresponding connecting pipes are closed by valves or sealed.”

14-13 INSPECTION

Before a gas installation is put into service, after any modification or repair and at each renewal of the entry referred to in section 14-15 below, the whole of the installation shall be submitted to an expert recognized by the Administration for inspection. At the time of the inspection, the expert shall check whether the installation complies with the requirements of this chapter.

The expert shall submit a report to the competent authority of the Administration.

14-14 TESTS AND TRIALS

The completed installation shall be subjected to the following tests and trials:

14-14.1 Medium-pressure piping between the first pressure reducer and the valves upstream of the final pressure reducer:

- (i) Strength test, carried out with air, an inert gas or a liquid at a pressure prescribed by the Administration. This pressure shall not be less than 2 MPa above atmospheric pressure;
- (ii) Gastightness test, carried out with air or an inert gas at a pressure of 350 kPa above atmospheric pressure.

14-14.2 Piping at the working pressure between the single or final pressure reducer and the valves upstream of the gas-consuming appliances:

Gastightness test, carried out with air or an inert gas at a pressure of 100 kPa above atmospheric pressure.

14-14.3 Piping situated between the single or final pressure reducer and the controls of the gas-consuming appliance:

Gastightness test at a pressure of 20 kPa above atmospheric pressure.

14-14.4 In the tests referred to in paragraph 14-14.1(ii), 14-14.2 and 14-14.3, the piping shall be considered gastight if, after sufficient time has elapsed for thermal balancing, no drop in the test pressure is noted during the following 10 minutes.

14-14.5 Receptacle connectors, piping and other fittings subjected to the pressure in the receptacles, and joint between the pressure reducer and the piping:

- (i) Strength test, carried out with air, an inert gas or liquid at the pressure prescribed by the Administration but in any case not less than 2.5 MPa above atmospheric pressure;
- (ii) Gastightness test, carried out with a foam-producing product at the working pressure.

14-14.6 All gas-consuming appliances shall, on being put into service, be tested at the working pressure to ensure that combustion is satisfactory with the controls in the different positions.

The safety devices shall be checked to ensure that they work properly.

14-14.7 After the test referred to in paragraph 14-14.6 above, trials shall be carried out with every gas-consuming appliance connected to a flue to check whether, after five minutes' operation at full capacity, with windows and doors closed and the ventilation devices in operation, any combustion gases are escaping through the air intake.

If combustion gases are escaping otherwise than sporadically, the cause shall immediately be sought and eliminated. The appliance shall not be approved until all defects have been corrected.

14-15 ENTRY IN THE APPROPRIATE VESSEL'S PAPER

14-15.1 For every gas installation, the appropriate vessel's paper shall contain an entry stating that the installation complies with the requirements of this chapter.

14-15.2 This entry shall be made by the competent authority of the Administration following the inspection referred to in section 14-13, above.

14-15.3 The entry shall be valid for a period not exceeding three years and may be renewed only after another inspection has been carried out in accordance with section 14-13.

At the request of the owner of the vessel, accompanied by a statement of his reasons for making the request, the Administration may extend the validity of the entry by not more than three months without carrying out the inspection referred to in section 14-13 above. Such extension shall be granted in a written document which shall be kept on board the vessel. Such extension shall not affect the date of the next scheduled inspection.

CHAPTER 15 SPECIAL PROVISIONS FOR PASSENGER VESSELS

15-1 GENERAL PROVISIONS

15-1.1 The following provisions shall not apply:

- (i) 8-1.6.2 sentence 2 and 8-1.6.7;
- (ii) 9-2.11.3 sentence 2 for rated voltages of over 50V.

15-1.2 The following items of equipment are prohibited on passenger vessels:

- (i) lamps powered by liquefied gas or liquid fuel;
- (ii) vaporizing oil-burner stoves;
- (iii) solid fuel heaters;
- (iv) devices fitted with wick burners;
- (v) liquefied gas devices according to chapter 14.

15-1.3 On passenger vessels, areas shall be provided for use by persons with reduced mobility, according to the provisions of this chapter. If the application of provisions of this chapter which take into account the specific safety needs of people with reduced mobility is difficult in practice or incurs unreasonable costs, the Administration can allow exceptions from these provisions.

15-2 VESSEL'S HULL

15-2.1 In the course of periodical inspections referred to in 2-4, the thickness of the outside plating of steel passenger vessels shall be determined as follows:

- (i) The minimum thickness t_{min} of the bottom, bilge and side plating of the outer hull of passenger vessels is determined in accordance with the larger value of the following formulae:

$$t_{1min} = 0.006 \cdot a \cdot \sqrt{T} \text{ [mm]}; \quad t_{2min} = f \cdot 0.55 \cdot \sqrt{L_{WL}} \text{ [mm]}.$$

In these formulae:

$$f = 1 + 0.0013 \cdot (a - 500);$$

a = longitudinal or transverse frame spacing [mm], and where the frame spacing is less than 400 mm, $a = 400$ mm should be entered.

- (ii) It is permissible to fall short of the minimum value determined in accordance with (i) above for the plate thickness in cases where the permitted value has been determined and certified on the basis of a mathematical proof for the sufficient strength (longitudinal, transverse and local) of the vessel's hull.
- (iii) At no point of the outside plating shall the thickness calculated in accordance with (i) or (ii) above be less than 3 mm.
- (iv) Plate renewals shall be carried out when bottom, bilge or side plate thicknesses have fallen short of the minimum value determined in accordance with (i) or (ii), in conjunction with (iii) above.

15-2.2 The number and position of bulkheads shall be selected such that, in the event of flooding, the vessel remains buoyant according to 15-3.7 to 15-3.13. Every portion of the internal structure which affects the efficiency of the subdivision of such vessels shall be watertight, and shall be of a design which will maintain the integrity of the subdivision.

15-2.3 The distance between the collision bulkhead and the forward perpendicular shall be at least $0.04 L_{WL}$ and not more than $0.04 L_{WL} + 2$ m.

15-2.4 A transverse bulkhead may be fitted with a bulkhead recess, if all parts of this offset lie within the safe area.

15-2.5 The bulkheads, which are taken into account in the damaged stability calculation according to 15-3.7 to 15-3.13, shall be watertight and be installed up to the bulkhead deck. Where there is no bulkhead deck, these bulkheads shall extend to a height at least 20 cm above the margin line.

15-2.6 The number of openings in these bulkheads shall be kept as low as is consistent with the type of construction and normal operation of the ship. Openings and penetrations shall not have a detrimental effect on the watertight function of the bulkheads.

15-2.7 Collision bulkheads shall have no openings and no doors.

15-2.8 Bulkheads according to 15-2.5 separating the engine rooms from passenger areas or crew and shipboard personnel accommodation shall have no doors.

15-2.9 Manually operated doors without remote control in bulkheads referred to in 15-2.5, are permitted only in areas not accessible to passengers. They shall:

- (i) remain closed at all times and be opened only temporarily to allow access;
- (ii) be fitted with suitable devices to enable them to be closed quickly and safely;
- (iii) display the following notice on both sides of the doors: "Close door immediately after passing through".

15-2.10 Doors in bulkheads referred to in 15-2.5, that are open for long periods shall comply with the following requirements:

- (i) They shall be capable of being closed from both sides of the bulkhead and from an easily accessible point above the bulkhead decks.
- (ii) After being closed by remote control the door shall be such that it can be opened again locally and closed safely. Closure shall not be impeded by carpeting, foot rails or other obstructions.
- (iii) The time taken for the remote-controlled closure process shall be at least 30 seconds but not more than 60 seconds.
- (iv) During the closure procedure an automatic acoustic alarm shall sound by the door.
- (v) The door drive and alarm shall also be capable of operating independently of the main on-board power supply. There shall be a device at the location of the remote control that displays whether the door is open or closed.

15-2.11 Doors in bulkheads referred to in 15-2.5, and their actuators shall be located in the safe area.

15-2.12 There shall be a warning system in the wheelhouse to indicate which of the doors in bulkheads referred to in 15-2.5 is open.

15-2.13 Open-ended piping and ventilation ducts shall be offset in such a way that, in any conceivable flooding, no additional spaces or tanks are flooded through them.

- (i) If several compartments are openly connected by piping or ventilation ducts, such piping and ducts shall, in an appropriate place, be lead above the waterline corresponding to the worst possible flooding.
- (ii) Piping need not meet the requirement above, if shut-off devices are fitted in the piping where it passes through the bulkheads and which can be remotely controlled from a point above the bulkhead deck.
- (iii) Where a pipework system has no open outlet in a compartment, the pipework shall be regarded as intact in the event of this compartment being damaged, if it runs within the safe area and is more than 0.50 m from the bottom of the vessel.

15-2.14 Remote controls of bulkhead doors according to 15-2.10 and shut-off devices according to 15-2.13 (ii) above the bulkhead deck shall be clearly indicated as such.

15-2.15 Where double bottoms are fitted, their height shall be at least 0.60 m, and where wing voids are fitted, their width shall be at least 0.60 m.

15-2.16 Windows may be situated below the margin line, if they are watertight, cannot be opened, possess sufficient strength and conform to 15-6.15.

15-3 STABILITY

15-3.1 It shall be proved by a calculation based on the results from the application of a standard for intact stability that the intact stability of the vessel is appropriate. All calculations shall be carried out free to heel, trim and sinkage.

15-3.2 The intact stability shall be proven for the following standard load conditions:

- (i) at the start of the voyage: 100 % passengers, 98 % fuel and fresh water, 10 % waste water;
- (ii) during the voyage: 100 % passengers, 50 % fuel and fresh water, 50 % waste water;
- (iii) at the end of the voyage: 100 % passengers, 10 % fuel and fresh water, 98 % waste water;
- (iv) unladen vessel: no passengers, 10 % fuel and fresh water, no waste water.

For all standard load conditions, the ballast tanks shall be considered as either empty or full in accordance with normal operational conditions.

As a precondition for changing the ballast whilst under way, the requirement of 15-3.3(iv) shall be proved for the following load condition:

100% passengers, 50% fuel and fresh water, 50% waste water, all other liquid (including ballast) tanks are considered filled to 50%.

If this condition cannot be met, an entry shall be made in the ship's certificate to the effect that, whilst under way, the ballast tanks can only be empty or full and that, whilst under way, the ballast conditions must not be changed.

15-3.3 The proof of adequate intact stability by means of a calculation shall be produced using the following definitions for the intact stability and for the standard load conditions mentioned in 15-3.2 i) to iv):

- (i) the maximum righting lever h_{max} shall occur at a heeling angle $\varphi_{max} \geq 15^\circ$ and shall not be less than 0.20 m. However, in case $\varphi_f < \varphi_{max}$ the righting lever at the downflooding angle φ_f shall not be less than 0.20 m;
- (ii) the downflooding angle φ_f shall not be less than 15° ;
- (iii) the area A under the curve of the righting levers shall, depending on the position of φ_f and φ_{max} , reach at least the following values:

| Case | | | A |
|------|---|--------------------------------|---|
| 1 | $\varphi_{max} = 15^\circ$ | | 0.07 m·rad to angle $\varphi = 15^\circ$ |
| 2 | $15^\circ < \varphi_{max} < 30^\circ$ | $\varphi_{max} \leq \varphi_f$ | $0.055 + 0.001 \cdot (30 - \varphi_{max})$ m·rad to angle φ_{max} |
| 3 | $15^\circ < \varphi_f < 30^\circ$ | $\varphi_{max} > \varphi_f$ | $0.055 + 0.001 \cdot (30 - \varphi_f)$ m·rad to angle φ_f |
| 4 | $\varphi_{max} \geq 30^\circ$ and $\varphi_f \geq 30^\circ$ | | 0.055 m·rad to angle $\varphi = 30^\circ$ |

where: h_{max} is the maximum lever;

φ is the heeling angle;

φ_f is the downflooding angle, that is the heeling angle, at which openings in the hull, in the superstructure or deck houses which cannot be closed so as to be weather tight, submerge;

φ_{max} is the heeling angle at which the maximum righting lever occurs;

A area beneath the curve of the righting levers.

- (iv) the initial metacentric height, \overline{GM}_0 , corrected by the effect of the free surfaces of liquid in tanks, shall not be less than 0.15 m;
- (v) in each of the following two cases the heeling angle shall not exceed 12° :
 - in application of the heeling moment due to passengers and wind according to 15-3.4 and 15-3.5;
 - in application of the heeling moment due to passengers and turning according to 15-3.4 and 15-3.6;
- (vi) for a heeling moment resulting from moments due to passengers, wind and turning according to 15-3.4, 15-3.5 and 15-3.6, the residual freeboard shall be not less than 200 mm;
- (vii) for vessels with windows or other openings in the hull located below the bulkhead decks and not closed watertight, the residual safety clearance shall be at least 100 mm on the application of the three heeling moments resulting from subsection (vi).

15-3.4 The heeling moment due to one-sided accumulation of persons shall be calculated according to the following formulae:

$$M_p = g \cdot P \cdot y = g \cdot \sum P_i \cdot y_i \text{ [kNm]}$$

where: P = total mass of persons on board in [t], calculated by adding up the maximum permitted number of passengers and the maximum number of shipboard personnel and crew under normal operating conditions, assuming an average mass per person of 0.075 t;

y = lateral distance of centre of gravity of total mass of persons P from centre line in [m];

g = acceleration of gravity ($g = 9.81 \text{ m/s}^2$);

P_i = mass of persons accumulated on area A_i in [t];

$$P_i = n_i \cdot 0.075 \cdot A_i \text{ [t]}$$

where: A_i = area occupied by persons in [m²];

n_i = number of persons per square meter.

n_i = 4 for free deck areas and deck areas with movable furniture; for deck areas with fixed seating furniture such as benches, n_i shall be calculated by assuming an area of 0.45 m in width and 0.75 m in seat depth per person;

y_i = lateral distance of geometrical centre of area A_i from centre line in [m].

The calculation shall be carried out for an accumulation of persons both to starboard and to port.

The distribution of persons shall correspond to the most unfavourable one from the point of view of stability. Cabins shall be assumed unoccupied for the calculation of the persons' heeling moment.

For the calculation of the loading cases, the centre of gravity of a person should be taken as 1 m above the lowest point of the deck at $0.5 L_{WL}$, ignoring any deck curvature and assuming a mass of 0.075 t per person.

A detailed calculation of deck areas which are occupied by persons may be dispensed with if the following values are used:

$$P = \begin{array}{ll} 1.1 \cdot F_{max} \cdot 0.075 & \text{for day trip vessels} \\ 1.5 \cdot F_{max} \cdot 0.075 & \text{for cabin vessels} \end{array}$$

where: F_{max} = maximum permitted number of passengers on board;

Y = $B/2$ in [m].

15-3.5 The heeling moment due to wind pressure (M_{wst}) shall be calculated as follows:

$$M_{wst} = p_w \cdot A_w \cdot (l_w + T/2) \text{ [kNm]}$$

where: p_w = the specific wind pressure of 0.15 kN/m² for zone 3 and 0.25 kN/m² for zones 1 and 2;

A_w = lateral plane of the vessel above the waterline according to the considered load conditions as given in 15-3.2, in m²;

l_w = distance of the centre of gravity of the lateral plane A_w from the waterline according to the considered load conditions as given in 15-3.2, in m.

15-3.6 The heeling moment due to centrifugal force (M_{cf}), caused by the turning of the vessel, shall be calculated as follows:

$$M_{cf} = c_{cf} \cdot C_B \cdot v^2 \cdot D/L_{WL} \cdot (KG - T/2) \text{ [kNm]}$$

where: c_{cf} = a coefficient of 0.45;
 C_B = block coefficient (if not known, taken as 1.0);
 v = maximum speed of the vessel in m/s;
 KG = distance between the centre of gravity and the baseline in m.

For passenger vessels with propulsion systems according to 6-6, M_{cf} shall be derived from full-scale or model tests or else from corresponding calculations.

15-3.7 It shall be proved, by means of a calculation that the damaged stability of the vessel is appropriate.

15-3.8 Buoyancy of the vessel in the event of flooding shall be proven for the standard load conditions specified in 15-3.2. Accordingly, mathematical proof of sufficient stability shall be determined for the three intermediate stages of flooding (25%, 50% and 75% of flood build-up) and for the final stage of flooding.

15-3.9 Vessels operating in zones 1, 2 and 3 shall comply with 2-compartment status ^{3/} except for vessels not exceeding 45 m in length and intended for the carriage of at most 250 passengers which may have 1-compartment status. However, vessels which are required to have 2-compartment status and which operate in zones 2 and 3 may have 1-compartment status on condition that they have a double skin, with a minimum distance between outer and inner skins of 0.6 m and the space enclosed by the outer and inner skins is subdivided to 2-compartment status. In zone 3, Basin administrations may allow the 1-compartment status.

The following assumptions concerning the extent of damage shall be taken into account in the event of flooding:

- (i) assumed dimensions of damages applicable to 1-compartment status and 2-compartment status are stated in the table below:

| Dimension of the side damage | | |
|--------------------------------|---------|--|
| longitudinal | l [m] | $1.20 + .07 \cdot L_{WL}$ |
| transverse | b [m] | $B/5$ |
| Vertical | h [m] | from the bottom upwards without delimitation |
| Dimension of the bottom damage | | |
| longitudinal | l [m] | $1.20 + 0.07 \cdot L_{WL}$ |
| transverse | b [m] | $B/5$ |
| vertical | h [m] | 0.59, pipework installed according to 15-2.13 (iii) shall be deemed intact |

- (ii) For 1-compartment status the bulkheads can be assumed to be intact if the distance between two adjacent bulkheads is greater than the damage length. Longitudinal bulkheads at a distance of less than $B/3$ from the outer plating measured perpendicular to centre line from the shell plating at the maximum draught shall not be taken into account for calculation purposes;

^{3/} The Basin administration may waive the requirements prescribed in this paragraph with regard to the 2-compartment status.

- (iii) For 2-compartment status, each bulkhead within the extent of damage, will be assumed to be damaged. The vessel shall remain buoyant after flooding;
- (iv) The lowest point of every non-watertight opening (e.g. doors, windows, access hatchways) shall lie at least 0.10 m above the damaged waterline. The bulkhead deck shall not be immersed in the final stage of flooding;
- (v) Permeability is assumed to be 95%. If it is proven by a calculation that the average permeability of any compartment is less than 95%, the calculated value can be used instead;

The values to be adopted shall not be less than:

| | |
|--|-----------|
| Lounges | 95 % |
| Engine and boiler rooms | 85 % |
| Luggage and store rooms | 75 % |
| Double bottoms, fuel bunkers, ballast tanks and other tanks, depending on whether, according to their intended purpose, they are to be assumed to be full or empty for the vessel floating at the plane of maximum draught | 0 or 95 % |

The calculation of free surface effect in intermediate stages of flooding shall be based on the gross surface area of the damaged compartments;

- (vi) If damage of a smaller dimension than specified above produces more detrimental effects with respect to heeling or loss of metacentric height, such damage shall be taken into account for calculation purposes.

15-3.10 For all intermediate stages of flooding referred to in 15-3.8, the following criteria shall be met:

- (i) the heeling angle φ at the equilibrium position of the intermediate stage in question shall not exceed 15° ;
- (ii) beyond the heel in the equilibrium position of the intermediate stage in question, the positive part of the righting lever curve shall display a righting lever value of $GZ \geq 0.02 m$ before the first unprotected opening becomes immersed or a heeling angle φ of 25° is reached;
- (iii) non-watertight openings shall not be immersed before the heel in the equilibrium position of the intermediate stage in question has been reached.

15-3.11 During the final stage of flooding, the following criteria shall be met taking into account the heeling moment due to passengers in accordance with 15-3.4:

- (i) the heeling angle φ_E shall not exceed 10° ;
- (ii) beyond the equilibrium position the positive part of the righting lever curve shall display a righting lever value of $GZ_R \geq 0.05 m$ with an area $A \geq 0.0065 m rad$. These minimum values for stability shall be met until the immersion of the first unprotected opening or in any case before reaching a heeling angle $\varphi_m \leq 25^\circ$;
- (iii) non-watertight openings shall not be immersed before the equilibrium position has been reached; if such openings are immersed before this point, the rooms affording access are deemed to be flooded for damaged stability calculation purposes.

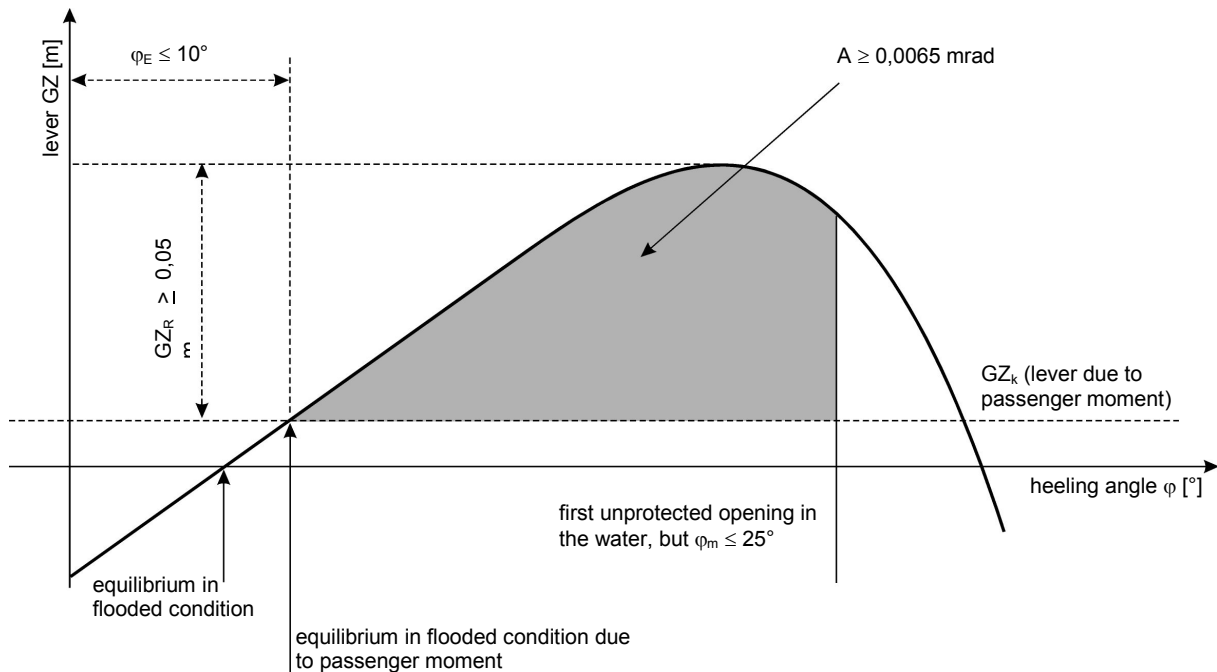

15-3.12 The shut-off devices which shall be able to be closed watertight shall be marked accordingly.

15-3.13 If cross-flood openings to reduce asymmetrical flooding are provided, they shall meet the following conditions:

- (i) for the calculation of cross-flooding, IMO Resolution A.266 (VIII) shall be applied;
- (ii) they shall be self-acting;
- (iii) they shall not be equipped with shut-off devices;
- (iv) the total time allowed for compensation shall not exceed 15 minutes.

15-4 SAFETY CLEARANCE AND FREEBOARD

15-4.1 The safety clearance shall be at least equal to the sum of:

- (i) the additional lateral immersion, which, measured on the outside plating, is produced by the permissible heeling angle according to 15-3.3(v); and
- (ii) the residual safety clearance according to 15-3.3(vii).

For vessels without a bulkhead deck, the safety clearance shall be not less than: 1900 mm in zone 1, 1000 mm in zone 2 and 500 mm in zone 3.

15-4.2 The freeboard shall be at least equal to the sum of:

- (i) the additional lateral immersion, which, measured on the outside plating, is produced by the heeling angle according to 15-3.3(v), and
- (ii) the residual freeboard according to 15-3.3(vi).

However, the remaining freeboard shall be not less than: 600 mm in zone 1, 400 mm in zone 2 and 300 mm in zone 3.

15-4.3 The maximum draught level is to be set so as to ensure compliance with the safety clearance according to 15-4.1, and the freeboard according to 15-4.2, 15-2 and 15-3.

15-4.4 For safety reasons, the Administration may stipulate a greater safety clearance or a greater freeboard.

15-5 MAXIMUM PERMITTED NUMBER OF PASSENGERS

15-5.1 The Administration sets the maximum permitted number of passengers and enters this number on the certificate.

15-5.2 The maximum permitted number of passengers shall not exceed any of the following values:

- (i) number of passengers for whom the existence of an evacuation area according to 15-6.8 has been proven;
- (ii) number of passengers that has been taken into account for the stability calculation according to 15-3;
- (iii) number of available berths for passengers on cabin vessels used for voyages including overnight stays.

15-5.3 For cabin vessels which are also used as day trip vessels, the number of passengers shall be calculated for use, both as a day trip vessel and as a cabin vessel, and entered on the certificate.

15-5.4 The maximum permitted number of passengers shall be displayed on clearly legible and prominently positioned notices on board the vessel.

15-6 PASSENGER ROOMS AND AREAS

15-6.1 Passenger rooms shall:

- (i) on all decks, be located aft of the level of the collision bulkhead and, as long as they are below the bulkhead deck, forward of the level of the aft-peak bulkhead;
- (ii) be separated from the engine and boiler rooms in a gas-tight manner; and
- (iii) be so arranged, that sight lines in accordance with 7-2 do not pass through them.

15-6.2 Cupboards and rooms referred to in 3A-3 and intended for the storage of flammable liquids shall be outside the passenger area.

15-6.3 The number and width of the exits of passenger rooms shall comply with the following requirements:

- (i) Rooms or groups of rooms designed or arranged for 30 or more passengers or including berths for 12 or more passengers shall have at least two exits. On day trip vessels, one of these two exits can be replaced by two emergency exits;
- (ii) If rooms are located below the bulkhead deck, one of the exits can be a watertight bulkhead door, according to 15-2.10, leading into an adjacent compartment from which the upper deck can be reached. The other exit shall lead directly or, if permitted in accordance with (i), as an emergency exit into the open air, or to the bulkhead deck. This requirement does not apply to individual cabins;

- (iii) Exits according to (i) and (ii) shall be suitably arranged and shall have a clear width of at least 0.80 m and also a clear height of at least 2.00 m. For doors of passenger cabins and other small rooms, the clear width can be reduced to 0.70 m;
- (iv) In the case of rooms or groups of rooms intended for more than 80 passengers the sum of the widths of all exits intended for passengers and which shall be used by them in an emergency, shall be at least 0.01 m per passenger;
- (v) If the total width of the exits is determined by the number of passengers, the width of each exit shall be at least 0.005 m per passenger;
- (vi) Emergency exits shall have a shortest side at least 0.60 m long or a minimum diameter of 0.70 m. They shall open in the direction of escape and be marked on both sides;
- (vii) Exits of rooms intended for use by persons with reduced mobility shall have a clear width of at least 0.90 m. Exits normally used for embarking and disembarking people with reduced mobility shall have a clear width of at least 1.50 m.

15-6.4 Doors of passenger rooms shall comply with the following requirements:

- (i) With the exception of doors leading to connecting corridors, they shall be capable of opening outwards or be constructed as sliding doors;
- (ii) Cabin doors shall be made in such a way that they can also be unlocked from the outside at any time;
- (iii) Powered doors shall open easily in the event of failure of the power supply to this mechanism;
- (iv) For doors intended for use by persons with reduced mobility, there shall be from the direction from which the door opens, a minimum clearance of 0.60 m between the inner edge of the doorframe on the lock side and an adjacent perpendicular wall.

15-6.5 Connecting corridors shall comply with the following requirements:

- (i) They shall have a clear width of at least 0.80 m or, if they lead to rooms used by more than 80 passengers, at least 0.01 m per passenger;
- (ii) Their clear height shall be not less than 2.00 m;
- (iii) Connecting corridors intended for use by persons with reduced mobility shall have a clear width of 1.30 m. Connecting corridors more than 1.50 m wide shall have hand rails on either side;
- (iv) Where a part of the vessel or a room intended for passengers is served by a single connecting corridor, the clear width thereof shall be at least 1.00 m;
- (v) Connecting corridors shall be free of steps;
- (vi) They shall lead only to open decks, rooms or staircases;
- (vii) Dead ends in connecting corridors shall be not longer than 2.00 m.

15-6.6 In addition to the provisions of 15-6.5, escape routes shall also comply with the following requirements:

- (i) Stairways, exits and emergency exits shall be so disposed that, in the event of a fire in any given area, the other areas may be evacuated safely;

- (ii) The escape routes shall lead by the shortest route to evacuation areas according to 15-6.8;
- (iii) Escape routes shall not lead through engine rooms or galleys;
- (iv) There shall be no rungs, ladders or the like installed at any point along the escape routes;
- (v) Doors to escape routes shall be constructed in such a way as not to reduce the minimum width of the escape route referred to in 15-6.5(i) or (iv);
- (vi) Escape routes and emergency exits shall be clearly signed. The signs shall be lit by the emergency lighting system.

15-6.7 Escape routes and emergency exits shall have a suitable safety guidance system.

15-6.8 For all persons on board, there shall be muster areas available which satisfy the following requirements:

- (i) The total area of the muster areas in m^2 shall correspond to at least the value produced by the following formulae:

$$\text{Day trip vessels: } A_S = 0,35 \cdot F_{max} [m^2]$$

$$\text{Cabin vessels: } A_S = 0,45 \cdot F_{max} [m^2]$$

In these formulae, the following definition applies:

F_{max} = maximum permitted number of passengers on board;

- (ii) Each individual muster or evacuation area shall be larger than $10 m^2$;
- (iii) The muster areas shall be clear of furniture, whether movable or fixed;
- (iv) If movable furniture is located in a room in which muster areas are defined, it shall be secured appropriately to avoid slipping;
- (v) Life-saving appliances shall be easily accessible from the evacuation areas;
- (vi) It shall be possible to evacuate people safely from these evacuation areas, using either side of the vessel;
- (vii) The muster areas shall lie above the margin line;
- (viii) The muster and evacuation areas are to be shown as such in the safety plan and signposted on board the vessel;
- (ix) If fixed seats or benches are located in a room in which muster areas are defined the corresponding number of persons need not be taken into account when calculating the total area of muster areas according to (i). However, the number of persons for whom fixed seats or benches in a certain room are taken into account must not exceed the number of persons for whom muster areas are available in this room;
- (x) The provisions of (iv) and (ix) also apply to free decks on which muster areas are defined;
- (xi) If collective life-saving appliances complying with 10-5.1.1.1, are available on board, the number of persons for whom such appliances are available may be disregarded when calculating the total surface area of the muster areas referred to in (i);
- (xii) However, in all cases where reductions to (ix) to (xi) are applied the total area according to (i) shall be sufficient for at least 50 % of the maximum permitted number of passengers.

15-6.9 Stairs and their landings in the passenger areas shall comply with the following requirements:

- (i) They shall be constructed in accordance with a recognized international standard;
- (ii) They shall have a clear width of at least 0.80 m or, if they lead to connecting corridors or areas used by more than 80 passengers, at least 0.01 m per passenger;
- (iii) They shall have a clear width of at least 1.00 m if they provide the only means of access to a room intended for passengers;
- (iv) Where there is not at least one staircase on each side of the vessel in the same room, they shall lie in the safe area;
- (v) In addition, stairs intended for use by persons with reduced mobility shall comply with the following requirements:
 - the gradient of the stairs shall not exceed 32°;
 - the stairs shall have a clear width of at least 0.90 m;
 - spiral staircases are not allowed;
 - the stairs shall not run in a direction transverse to the vessel;
 - the handrails of the stairs shall extend approximately 0.30 m beyond the top and bottom of the stairs without restricting traffic routes;
 - handrails, front sides of at least the first and the last step as well as the floor coverings at the ends of the stairs shall be colour highlighted.

15-6.10 Lifts intended for persons with reduced mobility, and lifting equipment, like stairlifts or lifting platforms, shall be constructed according to a relevant standard or a regulation of the Administration.

15-6.11 Parts of the deck intended for passengers, and which are not enclosed, shall comply with the following requirements:

- (i) They shall be surrounded by a fixed bulwark or guard rail at least 1.00 m high or a railing according to a recognized international standard. Bulwarks and railings of decks intended for use by persons with reduced mobility shall be at least 1.10 m high;
- (ii) Openings and equipment for embarking or disembarking and also openings for loading or unloading shall be such that they can be secured and have a clear width of at least 1.00 m. Openings, used normally for the embarking or disembarking of persons with reduced mobility, shall have a clear width of at least 1.50 m;
- (iii) If the openings and equipment for embarking or disembarking cannot be observed from the wheelhouse, optical or electronic aids shall be provided;
- (iv) Passengers sitting down shall not interrupt sight lines in accordance with 7-2.

15-6.12 The parts of the vessel not intended for passengers, in particular access to the wheelhouse, to the winches and to the engine rooms, shall be such that they can be secured against unauthorized entry. At any such access, a symbol corresponding to sketch 1 in appendix 3 shall be displayed in a prominent position.

15-6.13 Gangways shall be constructed in accordance with a recognized international standard. By way of derogation from 10-2.1 fifth indent, their length can be less than 4 m.

15-6.14 Traffic areas intended for use by persons with reduced mobility shall have a clear width of 1.30 m and be free of doorsteps and sills more than 0.025 m high. Walls in traffic areas, intended for use by persons with reduced mobility shall be equipped with handrails at a height of 0.90 m above the floor.

15-6.15 Glass doors and walls in traffic areas and also window panes shall be manufactured from pre-stressed glass or laminated glass. They may also be made from a synthetic material, provided this is authorized for use in a fire-protection context.

Transparent doors and transparent walls extending as far as the floor on traffic areas shall be prominently marked.

15-6.16 Superstructures or their roofs consisting completely of panoramic panes shall only be manufactured from materials which, in the event of an accident, reduce as much as possible the risks of injury to the persons on board.

15-6.17 Potable water systems shall, at least, comply with the requirements of 12-8.

15-6.18 There shall be toilets available for passengers. At least one toilet shall be fitted for use by persons with reduced mobility according to a relevant standard or a regulation of the Administration and shall be accessible from areas intended for use by persons with reduced mobility.

15-6.19 Cabins without an opening window shall be connected to a ventilation system.

15-7 PROPULSION SYSTEM ^{4/}

15-7.1 In addition to the main propulsion system, vessels shall be equipped with a second independent propulsion system so as to ensure that, in the event of a breakdown affecting the main propulsion system, the vessel can continue to make steerageway under its own power.

15-7.2 The second independent propulsion system shall be placed in a separate engine room. If both engine rooms have common partitions, these shall be built according to 15-11.2.

15-8 SAFETY DEVICES AND EQUIPMENT

15-8.1 All passenger vessels shall have internal communication facilities according to 7-6.6.3. Such facilities shall also be available in the operational rooms and - where there is no direct communication from the wheelhouse - in the muster and evacuation areas for passengers as referred to in 15-6.8.

15-8.2 All passenger areas shall be reachable via a loudspeaker system. The system shall be designed in such a way as to ensure that the information transmitted can be clearly distinguished from background noise. Loudspeakers are optional where direct communication between the wheelhouse and the passenger area is possible.

15-8.3 The vessel shall be equipped with an alarm system. The system shall include:

- (i) An alarm system enabling passengers, crew members and shipboard personnel to alert the vessel's command and crew.

^{4/} The Basin administration may waive the requirements prescribed in this section.

This alarm shall be given only in areas assigned to the vessel's command and to the crew; it shall only be possible for the vessel's command to stop the alarm. The alarm shall be capable of being triggered from at least the following places:

- in each cabin;
- in the corridors, lifts and stairwells, with the distance to the nearest trigger not exceeding 10 m and with at least one trigger per watertight compartment;
- in lounges, dining rooms and similar recreation rooms;
- in toilets, intended for use by persons with reduced mobility;
- in engine rooms, galleys and similar rooms where there is a fire risk;
- in the cold-storage rooms and other store rooms.

The alarm triggers shall be installed at a height above the floor of 0.85 m to 1.10 m.

- (ii) An alarm system enabling the vessel's command to alert passengers.

This alarm shall be clearly and unmistakably audible in all rooms accessible to passengers. It shall be capable of being triggered from the wheelhouse and from a location that is permanently staffed.

- (iii) An alarm system enabling the vessel's command to alert the crew and shipboard personnel.

The alarm system referred to in 7-5.2, shall also reach the recreation rooms for the shipboard personnel, the cold-storage rooms and other store rooms.

Alarm triggers shall be protected against unintentional use.

15-8.4 Each watertight compartment shall be fitted with a bilge level alarm.

15-8.5 Two motor-driven bilge pumps shall be provided.

15-8.6 A permanently installed bilge system according to 8-1.6.4, shall be provided on board.

15-8.7 Cold storage room doors, even when locked, shall also be capable of being opened from the inside.

15-8.8 Where CO₂ bar-systems are situated in rooms below deck these rooms shall be fitted with an automatic ventilation system. The ventilation ducts shall run down to 0.05 m from the floor of this room.

15-8.9 In addition to the first-aid kit specified in 10-2.1, additional first-aid kits shall be provided in sufficient number. The first-aid kits and their storage shall comply with the requirements set out in 10-2.1, ninth indent.

15-9 LIFE-SAVING APPLIANCES

15-9.1 In addition to the life jackets specified in 10-5.4.2.1 (iii) and 10-5.4.3 (ii) passenger vessels shall be supplied with additional lifejackets for children in quantity equal to 10 per cent of the total number of passengers.

15-9.2 In addition to the lifebuoys specified in 10-5.4.2.1 (iv) and 10-5.4.3 (iii) all parts of the deck intended for passengers and not enclosed shall be equipped with lifebuoys on both sides of the vessel, positioned not more than 20 m apart. The Administration may require lifebuoys to

be fitted with lifelines or self-igniting lights additionally to those referred to in 10-5.2.3.2.

15-9.3 For vessels with 2-compartment status or 1-compartment status and having double skins the administration may reduce the aggregate capacity of collective life-saving appliances referred to in 10-5.4.2.1 or 10-5.4.3.

15-10 ELECTRICAL EQUIPMENT

15-10.1 Only electrical equipment is permitted for lighting.

15-10.2 The provision of 9-2.13.4 applies also for passageways and recreation rooms for passengers.

15-10.3 For the following rooms and locations, adequate lighting shall be provided:

- (i) locations where life-saving equipment is stored and where such equipment is normally prepared for use;
- (ii) escape routes, access for passengers, including gangways, entrances and exits, connecting corridors, lifts and accommodation area companionways, cabin areas and accommodation areas;
- (iii) markings on the escape routes and emergency exits;
- (iv) in other areas intended for use by persons with reduced mobility;
- (v) control centres, engine rooms, steering equipment rooms and their exits;
- (vi) wheelhouse;
- (vii) emergency power supply room;
- (viii) points at which extinguishers and fire extinguishing equipment controls are located;
- (ix) areas in which passengers, shipboard personnel and crew muster in the event of danger.

15-10.4 In addition to 9-2.16.6, adequate emergency lighting shall be provided for the following rooms and locations:

- (i) escape routes, access for passengers, including gangways, entrances and exits, connecting corridors, lifts and accommodation area companionways, cabin areas and accommodation areas;
- (ii) markings on the escape routes and emergency exits;
- (iii) in other areas intended for use by persons with reduced mobility;
- (iv) control centres, steering equipment rooms and their exits;
- (v) emergency power supply room;
- (vi) points at which extinguishers and fire extinguishing equipment controls are located.

15-10.5 In addition to 9-2.16.5 the capacity of the emergency source shall be sufficient to supply also:

- (i) audible warning devices;
- (ii) a searchlight that can be operated from the wheelhouse;
- (iii) fire alarm system;
- (iv) lifts and lifting equipment within the meaning of 15-6.10.

15-11 FIRE PROTECTION

15-11.1 The suitability for fire protection of materials and components shall be established by a competent body recognized by the Administration on the basis of appropriate test methods.

15-11.2 Partitions between rooms shall be designed in accordance with the following tables:

Table for partitions between rooms, in which no pressurized sprinkler systems according to 10-3.6 are installed:

| Rooms | Control centres | Stairwells | Muster areas | Lounges | Engine rooms | Galleys | Store rooms |
|-----------------|-----------------|------------|----------------------|------------------------|-------------------------|---------|---------------------------|
| Control centres | - | A0 | A0/B15 ^{*/} | A30 | A60 | A60 | A60 |
| Stairwells | | - | A0 | A30 | A60 | A60 | A60 |
| Muster areas | | | - | A30/B15 ^{**/} | A60 | A60 | A60 |
| Lounges | | | | -/B15 ^{***/} | A60 | A60 | A60 |
| Engine rooms | | | | | A60/A0 ^{****/} | A60 | A60 |
| Galleys | | | | | | A0 | A60/B15 ^{*****/} |
| Store rooms | | | | | | | - |

Table for partitions between rooms, in which pressurized sprinkler systems according to 10-3.6 are installed:

| Rooms | Control centres | Stairwells | Muster areas | Lounges | Engine rooms | Galleys | Store rooms |
|-----------------|-----------------|------------|----------------------|------------------------|-------------------------|---------|-------------|
| Control centres | - | A0 | A0/B15 ^{*/} | A0 | A60 | A60 | A30 |
| Stairwells | | - | A0 | A0 | A60 | A30 | A0 |
| Muster areas | | | - | A30/B15 ^{**/} | A60 | A60 | A60 |
| Lounges | | | | -/B0 ^{***/} | A60 | A30 | A0 |
| Engine rooms | | | | | A60/A0 ^{****/} | A60 | A60 |
| Galleys | | | | | | - | B15 |
| Store rooms | | | | | | | - |

(i) Type "A" partitions are bulkheads, walls and decks which satisfy the following requirements:

- They are made of steel or of another equivalent material.
- They are appropriately stiffened.
- They are insulated with an approved non-combustible material such that the average temperature on the side facing away from the fire rises to not more than 140°C above the initial temperature and at no point, including the gaps at the

^{*/} Partitions between control centres and internal muster areas shall correspond to Type A0, but external muster areas only to Type B15.

^{**/} Partitions between lounges and internal muster areas shall correspond to Type A30, but external muster areas only to Type B15.

^{***/} Partitions between cabins, partitions between cabins and corridors and vertical partitions separating lounges according to 15-11.10 shall comply with Type B15, for rooms fitted with pressurized sprinkler systems B0.

^{****/} Partitions between engine rooms according to 15-7 and 9-2.16.4 (ii), shall comply with Type A60; in other cases, they shall comply with Type A0.

^{*****/} B15 is sufficient for the partitions between galleys, on the one hand, and cold-storage rooms or food storage rooms, on the other.

joints, does a temperature increase of more than 180°C above the initial temperature occur within the following specified periods:

| | |
|----------|------------|
| Type A60 | 60 minutes |
| Type A30 | 30 minutes |
| Type A0 | 0 minutes. |

- They are constructed in such a way as to prevent the transmission of smoke and flames until the end of the one-hour normal fire test.
- (ii) Type-B partitions are bulkheads, walls, decks and ceilings together with facings that meet the following requirements:
- They are made of an approved non-combustible material. Furthermore, all materials used in the manufacture and assembly of partitions shall be non-combustible, except for the facing, which shall be at least flame-retardant.
 - They demonstrate an insulation value such that the average temperature on the side facing away from the fire rises to not more than 140°C above the initial temperature and at no point, including the gaps at the joints, does a temperature increase of more than 225°C above the initial temperature occur within the following specified periods:
- | | |
|----------|------------|
| Type B15 | 15 minutes |
| Type B0 | 0 minutes. |
- They are constructed in such a way as to prevent the transmission of flames until the end of the first half hour of the normal fire test.
- (iii) The Administration can prescribe a test on a sample partition in order to ensure compliance with the above provisions.

15-11.3 Paints, lacquers and other surface-treatment products as deck coverings used in rooms except engine rooms and store rooms shall be flame-retardant. Carpets, fabrics, curtains and other hanging textile materials as well as upholstered furniture and components of bedding shall be flame-retardant if the rooms in which they are located are not equipped with a pressurized sprinkler system according to 10-3.6.

15-11.4 Lounge ceilings and wall claddings, including their substructures, shall, where these lounges do not have a pressurized sprinkler system according to 10-3.6 be manufactured from non-combustible materials with the exception of their surfaces, which shall be at least flame-retardant.

15-11.5 Furniture and fittings in lounges which serve as muster areas shall, where the rooms do not have a pressurized sprinkler system according to 10-3.6, be manufactured from non-combustible materials.

15-11.6 Paints, lacquers and other materials used on exposed internal areas shall not produce excessive amounts of smoke or toxic substances.

15-11.7 Insulation materials in lounges shall be non-combustible. This does not apply to insulations used on coolant-carrying pipes. The surfaces of the insulation materials used on these pipes shall be at least flame-retardant.

15-11.8 Doors in partitions according to 15-11.2 shall satisfy the following requirements:

- (i) They shall satisfy the same requirements set out in 15-11.2 as the partitions themselves;
- (ii) They shall be self-closing in the case of doors in partition walls according to 15-11.10 or in the case of enclosures around engine rooms, galleys and stairwells;
- (iii) Self-closing doors which remain open in normal operation shall be such that they can be closed from a location permanently manned by the ship's personnel. Once a door has been remotely closed, it shall be possible to reopen and close it safely on the spot;
- (iv) Watertight doors according to 15-2 need not be insulated.

15-11.9 Walls according to 15-11.2 shall be continuous from deck to deck or end at continuous ceilings, which satisfy the same requirements as referred to in 15-11.2.

15-11.10 The following passenger areas shall be divided by vertical partitions as referred to in 15-11.2:

- (i) passenger areas with a total surface area of more than 800 m²;
- (ii) passenger areas in which there are cabins, at intervals of not more than 40 m.

The vertical partitions shall be smoke-tight under normal operating conditions and shall be continuous from deck to deck.

15-11.11 Hollows above ceilings, beneath floors and behind wall claddings shall be separated at intervals of not more than 14 m by non-combustible draught stops which, even in the event of fire, provide an effective fireproof seal.

15-11.12 Internal stairs and lifts shall be encapsulated at all levels by walls according to 15-11.2. The following exceptions are permissible:

- (i) a staircase connecting only two decks does not need to be encapsulated, if on one of the decks the staircase is enclosed according to 15-11.2;
- (ii) in a lounge, stairs need not be encapsulated if they are located entirely within the interior of this room, and
 - if this room extends over only two decks, or
 - if there is a pressurized sprinkler system according to 10-3.6 installed in this room on all decks, this room has a smoke extraction system according to 15-11.15 and the room has access on all decks to a stairwell.

15-11.13 Ventilation systems and air supply systems shall satisfy the following requirements:

- (i) They shall be designed in such a way as to ensure that they themselves do not cause the spread of fire and smoke;
- (ii) Openings for air intake and extraction and air supply systems shall be such that they can be closed off;
- (iii) Ventilation ducts shall be made of steel or an equivalent non-combustible material;
- (iv) When ventilation ducts with a cross-section of more than 0.02 m² are passed through partitions according to 15-11.2. of Type A or partitions according to 15-11.10, they shall be fitted with automatic fire dampers which can be operated from a location permanently manned by shipboard personnel or crew members;

- (v) Ventilation systems for galleys and engine rooms shall be separated from ventilation systems which supply other areas;
- (vi) Air extraction ducts shall be provided with lockable openings for inspection and cleaning. These openings shall be located close to the fire dampers;
- (vii) Built-in ventilators shall be such that they can be switched off from a central location outside the engine room.

15-11.14 Galleys shall be fitted with ventilation systems and stoves with extractors. The air extraction ducts of the extractors shall satisfy the requirements according to 15-11.13 and, additionally, be fitted with manually operated fire dampers at the inlet openings.

15-11.15 Control centres, stairwells and internal evacuation areas shall be fitted with natural or mechanical smoke extraction systems. Smoke extraction systems shall satisfy the following requirements:

- (i) They shall offer sufficient capacity and reliability;
- (ii) They shall comply with the operating conditions for passenger vessels;
- (iii) If smoke extraction systems also serve as general ventilators for the rooms, this shall not hinder their function as smoke extraction systems in the event of a fire;
- (iv) Smoke extraction systems shall have a manually operated triggering device;
- (v) Mechanical smoke extraction systems shall additionally be such that they can be operated from a location permanently manned by shipboard personnel or crew members;
- (vi) Natural smoke extraction systems shall be fitted with an opening mechanism, operated either manually or by a power source inside the ventilator;
- (vii) Manually operated triggering devices and opening mechanisms shall be accessible from inside or outside the room being protected.

15-11.16 Lounges not constantly supervised by shipboard personnel or crew members, galleys, engine rooms and other rooms presenting a fire risk shall be connected to an appropriate fire alarm system. The existence of a fire and its exact whereabouts shall be automatically displayed at a location permanently manned by shipboard personnel or crew members.

15-12 FIRE-FIGHTING

15-12.1 In addition to the portable extinguishers according to 10-3.1, at least the following portable extinguishers shall be available on board:

- (i) one extinguisher for every 120 m² of gross floor area in passenger areas;
- (ii) one portable extinguisher per group of 10 cabins, rounded upwards;
- (iii) one portable extinguisher in each galley and in the vicinity of any room in which flammable liquids are stored or used. In galleys the quenching material shall be suitable for fighting fat fires.

These additional fire extinguishers shall meet the requirements laid down in 10-3.2 and be installed and distributed on the vessel so that, in the event of a fire starting at any point and at any time, a fire extinguisher can be reached immediately. In every galley and also in hairdressing salons and perfumeries, there shall be a fire blanket to hand.

15-12.2 Passenger vessels shall be provided with a hydrant system referred to in 10-3.7, consisting of:

- (i) two motor-driven fire extinguishing pumps of sufficient capacity, at least one of which is permanently installed;
- (ii) one fire extinguisher line with a sufficient number of hydrants with permanently connected fire hoses at least 20 m in length and fitted with a standard nozzle capable of producing both a mist and a jet of water and incorporating a shut-off facility.

For smaller vessels the Basin administration may give exemptions from these requirements.

15-12.3 Hydrant systems shall be designed and dimensioned in such a way that:

- (i) any point of the vessel can be reached from at least two hydrants in different places, each with a single hose length of not more than 20 m; and
- (ii) the pressure at the hydrants is at least 300 kPa.

If a hydrant chest is provided, an “extinguisher hose” symbol similar to that shown in sketch 5 in appendix 3, of at least 10 cm side length, shall be affixed to the outside of the chest.

15-12.4 Hydrant valves or cocks shall be such that they can be set so that each of the fire hoses can be separated and removed during operation of the fire extinguishing pumps.

15-12.5 Fire hoses in the internal area shall be rolled up on an axially connected reel.

15-12.6 Materials for fire-fighting equipment shall either be heat-resistant or shall be suitably protected against failure to work when subjected to high temperatures.

15-12.7 Fire-fighting systems shall be arranged in such a way that they can be completely drained to avoid the possibility of freezing.

15-12.8 The fire pumps shall:

- (i) be located in separate rooms;
- (ii) be such that they can be operated independently of each other;
- (iii) each be capable, on all decks, of maintaining the necessary pressure at the hydrants;
- (iv) be installed forward of the aft bulkhead.

15-12.9 Engine rooms shall be fitted with a fixed fire extinguishing system according to 10-3.6.

15-12.10 On cabin vessels there shall be:

- (i) two self-contained breathing apparatus sets;
- (ii) two sets of equipment consisting of at least a protective suit, helmet, boots, gloves, axe, crowbar, torch and safety-line; and
- (iii) four smoke hoods.

15-13 SAFETY ORGANIZATION

15-13.1 A safety rota shall be provided on board passenger vessels. The safety rota describes the duties of the crew and the shipboard personnel in the following eventualities:

- (i) breakdown;
- (ii) fire on board;
- (iii) evacuation of passengers;
- (iv) person overboard.

Specific safety measures for persons with reduced mobility shall be taken into consideration.

The crew members and shipboard personnel designated in the safety rota should be assigned their various duties, depending on the posts they occupy. Special instructions to the crew shall ensure that, in the event of danger, all doors and openings in the watertight bulkheads referred to in 15-2 shall be closed immediately.

15-13.2 The safety rota includes a safety plan, in which at least the following are clearly and precisely designated:

- (i) areas intended for use by persons with reduced mobility;
- (ii) escape routes, emergency exits and muster and evacuation areas as referred to in 15-6.8;
- (iii) life-saving appliances and ship's boats;
- (iv) fire extinguishers, fire hydrants and hoses and fire extinguishing systems;
- (v) other safety equipment;
- (vi) the alarm system referred to in 15-8.3(i);
- (vii) the alarm system referred to in 15-8.3(ii) and (iii);
- (viii) the bulkhead doors referred to in 15-2.5, and the location of their controls, as well as the other openings referred to in 15-2.9, 15-2.10 and 15-2.13 and 15-3.12;
- (ix) doors pursuant to 15-11.8;
- (x) fire dampers;
- (xi) fire alarm system;
- (xii) emergency power plant;
- (xiii) ventilation system control units;
- (xiv) shore connections;
- (xv) fuel line shut-offs;
- (xvi) liquefied gas installations;
- (xvii) public address systems;
- (xviii) radiotelephone equipment;
- (xix) first-aid kits.

15-13.3 The safety rota according to 15-13.1 and the safety plan according to 15-13.2 shall:

- (i) be duly stamped by the Administration; and
- (ii) be prominently displayed at an appropriate point on each deck.

15-13.4 Details shall be posted up in each cabin showing the instructions in emergency cases for passengers together with a simplified safety plan containing only the information referred to in 15-13.2(i) to (vi).

The instructions shall include at least:

- (i) emergency cases
 - fire
 - flooding
 - general hazard
- (ii) description of various alarm signals
- (iii) information on
 - escape routes
 - what to do
 - need to keep calm
- (iv) information to prevent accidents due to
 - smoking
 - use of fire and open flames
 - opening windows
 - use of certain items of equipment

This information shall be prominently displayed in appropriate languages.

15-14 EXEMPTIONS FOR CERTAIN PASSENGER VESSELS

15-14.1 As an alternative to proving adequate stability after damage according to 15-3.7 to 15-3.13, passenger vessels with a length of not more than 25 m, authorised to carry up to a maximum of 50 passengers shall comply with the following criteria:

- (i) after symmetrical flooding, the immersion of the vessel shall not exceed the margin line; and
- (ii) the metacentric height GM_R shall not be less than 0.10 m.

The necessary residual buoyancy shall be assured through the appropriate choice of material used for the construction of the hull or by means of highly cellular foam floats, solidly attached to the hull. In the case of vessels with a length of more than 15 m, residual buoyancy can be ensured by a combination of floats and subdivision complying with the 1-compartment status according to 15-3.9.

15-14.2 If a vessel benefits from the derogations under 15-14.1, the equipment carried on board shall include - in addition to the life-saving equipment mentioned in 15-9.1 to 15-9.3 - collective life-saving equipment according to 10-5.1, in respect of 50% of the maximum number of permitted passengers.

15-14.3 Where appropriate, the Administration may waive the application of 10-5.1.4 in the case of passenger vessels intended to carry a maximum number of 250 passengers and with a length of not more than 25 m, provided that they are equipped with a suitable installation to enable persons to be recovered safely from the water. Such installations shall be subject to the following conditions:

- (i) one person alone shall be able to operate the installation;

- (ii) mobile installations are allowed;
- (iii) the installations shall be outside the danger area of the propulsion systems; and
- (iv) effective communication shall be possible between the boatmaster and the person in charge of the installation.

15-14.4 The Administration may waive the application of 10-5.1.4 in the case of passenger vessels certificated to carry a maximum number of 600 passengers and with a length of not more than 45 m, provided that the passenger vessel is equipped with a suitable installation as in 15-14.3 and the vessel has:

- (i) a rudder propeller, a cycloidal propeller or a water jet as main propulsion; or
- (ii) a main propulsion system with 2 propulsion units; or
- (iii) a main propulsion system and a bow-thruster.

15-14.5 By way of derogation from 15-2.9, passenger vessels with a length not exceeding 45 m and permitted to carry at most a number of passengers corresponding to the length of the vessel in metres are allowed to have on board, in the passenger area, a manually controlled bulkhead door without remote control according to 15-2.5, if:

- (i) the vessel has only one deck;
- (ii) this door is accessible directly from the deck and is not more than 10 m away from the exit to the deck;
- (iii) the lower edge of the door opening lies at least 30 cm above the floor of the passenger area; and
- (iv) each of the compartments divided by the door is fitted with a bilge level alarm.

15-14.6 The provision of 15-1.2(v) does not apply to passenger vessels with a length not exceeding 45 m when the liquefied gas installations are fitted with appropriate alarm systems for CO concentrations posing a health risk and for potentially explosive mixtures of gas and air.

15-14.7 The following provisions do not apply to passenger vessels up to 25 m long:

- (i) 15-4.1 last sentence;
- (ii) 15-6.6(iii), for the galleys, as long as a second escape route is available;
- (iii) 15-7.

15-14.8 For cabin vessels with a length of not more than 45 m 15-12.10 shall not be applied, provided smoke-hoods in a number corresponding to the number of berths are readily accessible in each cabin.

15-4.9 In addition to 1-1.8 the Administration may permit derogations for passenger vessels on its own territory without the restrictions in that section for the following:

- 15-3.9, two- compartment status;
- 15-7, second independent propulsion system; and
- 15-11.15, smoke extraction systems.

15-14.10 For passenger vessels in accordance with 15-14.1 the competent authority may permit minor derogations from the clear height required in 15-6.3 (iii) and 15-6.5 (ii).

The derogation shall not be more than 5%. In the case of derogations the relevant parts shall be indicated by colour.

CHAPTER 15A
SPECIFIC REQUIREMENTS FOR SAILING PASSENGER VESSELS

(Left void)

CHAPTER 16

SPECIFIC REQUIREMENTS APPLICABLE TO VESSELS INTENDED TO FORM PART OF A PUSHED OR TOWED CONVOY OR OF A SIDE-BY-SIDE FORMATION

16-1 VESSELS SUITABLE FOR PUSHING

16-1.1 Vessels suitable for pushing shall have at the bow a suitable pushing device so designed and equipped that, from the start of the coupling manoeuvres:

- (i) the vessel can take up a fixed position in relation to the pushed barges;
- (ii) the crew can perform easily and safely the manoeuvres required for coupling the vessel to the pushed barges.

16-1.2 Vessels suitable for pushing shall be equipped with at least two special winches or equivalent coupling devices, which shall satisfy the following requirements:

- (i) all components of the coupling device shall be capable of withstanding the maximum operational stresses imposed under the severest conditions to be encountered in the navigation zone for which the vessel is intended;
- (ii) the coupling devices shall ensure the rigid coupling with the pushed vessel or vessels;
where convoys consist of a pusher vessel and a single pushed vessel, the coupling devices may permit controlled articulation. The control systems required for this purpose shall easily absorb the forces to be transmitted and shall be capable of being controlled easily and safely. Sections 6-2 to 6-4 shall apply by analogy to such control systems;
- (iii) it shall be possible to couple the pusher vessel to both loaded and empty pushed barges;
- (iv) the coupling device shall be so positioned on deck as not to interfere with the operation of other deck mechanisms, and the parts of the coupling device shall not project beyond the vessel's breadth over-all.

16-1.3 Vessels intended to propel side-by-side formations shall be equipped with bollards or equivalent devices the number and arrangement of which permit the formation to be securely linked.

16-2 PUSHED BARGES

16-2.1 Chapters 5, 6, 7, sections 8-1.6.2 to 8-1.6.8 of chapter 8, section 10-2 of chapter 10, and chapter 12 shall not apply to pushed barges with no steering system, accommodation, engine room or boilers.

16-2.2 Ship-born barges having a length L of 40 m or less shall in addition meet the following construction requirements:

- (i) The watertight transverse bulkheads referred to in paragraph 3-4.1 shall not be required if the forward side is capable of bearing a load at least 2.5 times that stipulated for the collision bulkhead of an inland waterway vessel with the same draught, built to the requirements of a recognized Classification Society;

- (ii) Notwithstanding paragraph 8-1.6.1, double-bottomed compartments to which access is difficult only have to be drainable if their volume exceeds 5% of the water displacement of the ship-born barge at the maximum authorized loaded draught.

16-2.3 Vessels intended for use in convoys shall be equipped with coupling devices, bollards or equivalent devices, the number and arrangement of which permit a secure link with other vessels or vessels of the convoy.

16-3 TOWING VESSELS

16-3.1 Vessels to be used for towing operations shall meet the following requirements:

- (i) Towing equipment shall be arranged in such a way that its use does not impair the safety of the vessel, crew or the cargo;
- (ii) Vessels to be used for auxiliary or main towing shall be equipped with towing devices: a towing winch or a tow hook which shall be capable of slipping, for the towing winch, or safe release, for the tow hook, from the steering position;
- (iii) The towing devices shall be installed forward of the propeller plane. That requirement shall not apply to vessels steered by cycloidal propellers or similar propulsion units;
- (iv) Notwithstanding the requirements of (ii) above, in the case of vessels to be used solely for auxiliary towing, other towing devices such as a bollard, to be installed forward of the propeller plane, may be used.

16-3.2 The Basin administration may limit the length of the vessel to be used for downstream towing.

16-4 TESTS ON CONVOYS OF VESSELS

16-4.1 In order to issue the certificate of fitness of a pusher or a self-propelled vessel capable of propelling a rigid convoy, and to enter relevant particulars in the certificate, the competent authority shall decide whether and which convoys are to be presented to it for inspection and shall carry out the navigation tests referred to in section 5-2 with the convoy in the requested formation(s), which it considers to be least favourable. The convoy must meet the requirements set out in sections 5-2 to 5-10.

The competent authority shall check that the rigid coupling of all the vessels in the convoy is assured during the manoeuvres prescribed in chapter 5.

16-4.2 If, in the course of the tests referred to in section 16-4.1 above, special equipment installed on vessels that are being pushed or led side-by-side is used, such as propelling or manoeuvring installations or articulated couplings, in order to meet the requirements of sections 5-2 to 5-10, the following shall be mentioned in the certificate of the vessels propelling the convoy: the formation, its position, the name and official number of the vessels making part of the convoy and fitted with the special equipment used.

16-5 ENTRIES ON THE CERTIFICATE

16-5.1 If a vessel is intended to push a convoy, or to be pushed in a convoy, the certificate shall mention its compliance with the applicable requirements of sections 16-1 to 16-4 above.

16-5.2 The following particulars shall be entered in the certificate of the vessel intended to ensure propulsion of another vessel or a convoy:

- (i) the convoys and formations permitted;
- (ii) types of coupling;
- (iii) maximum coupling forces transmitted; and
- (iv) where appropriate, minimum tensile strength of the coupling cables for the longitudinal connection and the number of turns of the cable on the bollard.

CHAPTER 17

SPECIFIC REQUIREMENTS APPLICABLE TO FLOATING EQUIPMENT

(Left void)

CHAPTER 18

SPECIFIC REQUIREMENTS APPLICABLE TO WORKSITE CRAFT

(Left void)

CHAPTER 19

SPECIFIC REQUIREMENTS APPLICABLE TO HISTORIC VESSELS

(Left void)

CHAPTER 19A

SPECIFIC REQUIREMENTS APPLICABLE TO CANAL BARGES

(Left void)

CHAPTER 19B

SPECIFIC REQUIREMENTS APPLICABLE TO CRAFT NAVIGATING ON ZONE 4

(Left void)

CHAPTER 20

SPECIFIC REQUIREMENTS APPLICABLE TO SEA-GOING VESSELS

(Left void)

CHAPTER 21

SPECIFIC REQUIREMENTS APPLICABLE TO RECREATIONAL CRAFT

(Left void)

CHAPTER 22 STABILITY OF VESSELS CARRYING CONTAINERS

22-1 GENERAL

22-1.1 A cargo of containers is considered to be fixed when each individual container is firmly secured to the vessel hull by guides or tensioners and when its position cannot be altered during navigation.

22-1.2 The container cargo of vessels navigating in zone 1 must be fixed.

22-1.3 The equipment used to secure containers must satisfy the requirements laid down by the Administration.

22-1.4 The following two methods of calculation of stability of vessels carrying containers shall be considered as equally acceptable.

22-2 METHOD A

22-2.1 Stability calculation for vessels carrying non-fixed containers

22-2.1.1 In the case of the vessels carrying non-fixed containers any calculation method used to determine the vessel's stability shall conform to the following requirements:

- (i) The metacentric height \overline{MG} shall not be less than 1.00 m;
- (ii) Under the combined action of the centrifugal force produced by the turning of the vessel, the thrust of the wind and the flooded free surfaces, the heel shall not be more than 5° and the deck side shall not be submerged.

22-2.1.2 The heeling arm resulting from the centrifugal force due to the turning of the vessel shall be determined by the following formula:

$$h_{cf} = C_{cf} \cdot \frac{v^2}{L_{WL}} \cdot \left(KG - \frac{T'}{2} \right) \quad (m)$$

where, C_{cf} = parameter: ($C_{cf} = 0.04$) (s^2/m);

v = maximum speed of vessel in relation to the water (m/s);

KG = height of centre of gravity of loaded vessel above the baseline (m);

T' = average draught of loaded vessel (m).

22-2.1.3 The heeling arm resulting from the static effect of wind shall be determined according to the following formula:

$$h_{wst} = C_w \cdot \frac{A_w}{\Delta} \cdot \left(l_w + \frac{T'}{2} \right) \quad (m)$$

where, C_w = parameter: ($C_w = 0.025$) [t/m^2];

l_w = height of centre of gravity of lateral surface A_w above the water in relation to the water-line (m);

T' = average draught of loaded vessel (m).

22-2.1.4 The heeling arm resulting from the free surfaces exposed to rainwater and residual water inside the hold or double bottom shall be determined according to the following formula:

$$h_{fs} = \frac{C_{fs}}{\Delta} \cdot \sum (b \cdot 1 \cdot (b - 0.55\sqrt{b})) \quad (m)$$

where: C_{fs} = parameter: ($C_{fs} = 0.015$) [t/m^2];
 b = breadth of hold or section of hold concerned (m);
 l = length of hold or section of hold concerned (m).

22-2.1.5 For each load, half the fuel and freshwater supply must be taken into account.

22-2.1.6 The stability of a vessel loaded with non-fixed containers shall be considered adequate when the actual KG is not more than the KG_{max} produced by the formula. The KG_{max} must be calculated for various displacements covering the whole range of possible draughts:

$$(i) \quad KG_{max} = \frac{\overline{KM} + \frac{B_{WL}}{2F} \cdot (C'_{cf} \cdot \frac{T_a}{2} - h_{wst} - h_{fs})}{\frac{B_f}{2F} \cdot C'_{cf} + 1} \quad (m)$$

For $\frac{B_{WL}}{2F}$, no value below 11.5 shall be used ($11.5 = 1/\tan 5^\circ$);

$$(ii) \quad KG_{max} = \overline{KM} - 1.00 \quad (m)$$

The smaller value for KG_{max} produced by subparagraphs (i) or (ii) shall apply,

where: KG_{max} = maximum permissible height of the centre of gravity of the loaded vessel above the baseline (m);

\overline{KM} = metacentric height above the baseline (m) according to the approximation formula in 22-2.1.7;

F = actual freeboard at $1/2 L$ (m);

C'_{cf} = parameter for centrifugal force produced by turning;

$$C'_{cf} = \frac{(0.7 \cdot v)^2}{9.81 \cdot 1.25 \cdot L_F} = 0.04 \cdot \frac{v^2}{L_F} \quad [-]$$

v = maximum speed of vessel in relation to the water (m/s);

T_a = average draught (m);

h_{wst} = heeling arm resulting from the static effect of wind (see 22-2.1.3) (m);

h_{fs} = sum of heeling arms produced by flooded free surfaces (see 22-2.1.4) (m).

22-2.1.7 Approximation formula for \overline{KM} :

Where there is no curve plan available, the value of \overline{KM} for the calculation, according to 22-2.1.6 and 22-2.2.4 can be determined, for example, by the following approximation formulae:

(i) pontoon vessels:

$$\overline{KM} = \frac{B_{WL}^2}{(12.5 - \frac{T_a}{H}) \cdot T_a} + \frac{T_a}{2} \quad (m)$$

(ii) other vessels:

$$\overline{KM} = \frac{B_{WL}^2}{(12.7 - 1.2 \cdot \frac{T_a}{H}) \cdot T_a} + \frac{T_a}{2} \quad (m)$$

22-2.2 Stability calculation for vessels carrying fixed containers

22-2.2.1 In the case of vessels carrying fixed containers, any calculation method used to determine the stability of the vessel shall conform to the following requirements:

- (i) The metacentric height \overline{MG} shall not be less than 0.50 m;
- (ii) Under the combined action of the centrifugal force produced by the turning of the vessel, the thrust of the wind and the flooded free surfaces, no hull opening shall be submerged.

22-2.2.2 The heeling arm resulting from the centrifugal force produced by the turning of the vessel, the thrust of the wind and the flooded free surfaces shall be determined by the formulae referred to under paragraphs 22-2.1.2 – 22-2.1.4.

22-2.2.3 For each load, half the fuel and fresh water supply must be taken into account.

22-2.2.4 The stability of a vessel loaded with fixed containers shall be considered adequate when actual KG is less than or equal to the KG_{\max} calculated for the various displacements resulting from the possible variation in height.

22-3 **METHOD B**

22-3.1 Stability calculation for vessels carrying non-fixed containers

22-3.1.1 The stability of vessels carrying non-fixed containers must satisfy the following additional requirements:

22-3.1.2 The metacentric height \overline{MG} shall not be less than 1.00 m.

22-3.1.3 The permissible angle of heel φ_{perm} is compared with the angle of heel $\varphi_{wst/cf}$ resulting from the combined effect of the heeling moments produced by the static pressure of wind M_{wst} (see paragraph 15-3.5) and the effect of the centrifugal force on turning M_{cf} . In calculating M_{cf} in accordance with paragraph 15-3.6 the speed of the vessel before it begins its turn is taken as 0.8 of the maximum speed. This angle must not be greater than 5° or the critical angle φ_n at which the upper edge of the freeboard deck is submerged, with a view to determining which of these angles is the smaller; in other words one of the following requirements must be satisfied:

$$\varphi_{wst/cf} \leq \varphi_{perm} = 5^\circ \quad \text{or} \quad \varphi_{wst/cf} \leq \varphi_{perm} = \varphi_n, \quad \text{if } \varphi_n < 5^\circ$$

22-3.1.4 The angle of heel $\varphi_{wst/cf}$ should be determined from the static stability diagram in relation to the value of M_{wst} and M_{cf} as a result of constructions given in figure 22-3.1.4 where the origin of the coordinates is transposed to point O' on curve M, corresponding to the static angle of heel φ_{wst} , arising as a result of the application of the static moment M_{wst} , determined in accordance with 15-3.5.

The angle of heel $\varphi_{wst/cf}$ is determined by selecting a straight line BD parallel to the ordinates axis, assuming that the hatched areas O'CA above the curve up to the moment M_{cf} and ABD below the curve are equal.

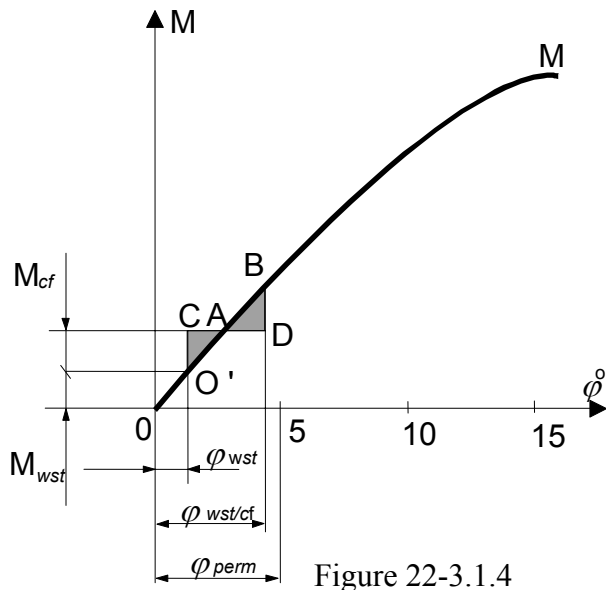

Figure 22-3.1.4

22-3.1.5 In determining the permissible moment produced by the dynamic inclinations M_{perm} , the permissible angle of heel ϕ_{perm} must be no greater than that given in paragraph 22-3.1.3.

22-3.1.6 If the requirements laid down in paragraphs 22-3.1.3 and 22-3.1.5 are not satisfied containers must be secured.

22-3.2 Stability calculation for vessels carrying fixed containers

22-3.2.1 The requirement regarding the stability of vessels carrying fixed containers is considered to be met, if the criteria for the stability of cargo vessels set out in paragraph 3-5.3.2 have been satisfied.

CHAPTER 22A

SPECIFIC REQUIREMENTS APPLICABLE TO CRAFT LONGER THAN 110 M

(Left void)

CHAPTER 22B

SPECIFIC REQUIREMENTS APPLICABLE TO HIGH-SPEED VESSELS

22B-1 GENERAL

22B-1.1 High-speed vessels shall not be built as cabin vessels.

22B-1.2 High-speed vessels shall be built under the supervision of a recognized Classification Society with rules intended for high-speed vessels in accordance with its classification requirements. The class assigned by a recognized Classification Society shall be maintained for the whole operation period of the vessel.

22B-1.3 Chapters 1 to 4, 6 to 12, 15 and 23 of the present Recommendations apply to high-speed vessels, unless otherwise specified in the present chapter.

22B-2 SEATS AND SEAT BELTS

22b-2.1 Seats shall be available for the permitted maximum number of persons on board. The construction of the seats and their attachment to the vessel structure shall be sufficiently strong.

22b-2.2 Seats shall be fitted with seat belts. The seat belts and their attachment points shall be sufficiently strong. Seat belts are optional if Basin administrations consider that they are not required.

22B-3 FREEBOARD

The minimum freeboard shall be 500 mm for open vessels (type C) and 200 mm for decked vessels (type A).

22B-4 BUOYANCY, STABILITY AND SUBDIVISION

22B-4.1 A vessel shall be provided with stability characteristics and stabilization systems adequate for safety when the vessel is operated in the non-displacement mode and during the transitional mode.

22B-4.2 A vessel shall be provided with buoyancy and stability characteristics adequate for safety when the vessel is operated in the displacement mode, both in the intact condition and the damaged condition.

22B-4.3 A vessel shall be provided with stability characteristics in the non-displacement and transitional modes adequate to transfer the vessel safely to displacement mode in case of any system malfunction.

22B-5 WHEELHOUSE

22B-5.1 The wheelhouse shall be so equipped that the helmsman and a second crew member can at all times perform their tasks while the vessel is under way.

22B-5.2 The wheelhouse shall be equipped in such a way as to provide the helmsman and a second crew member with a work station. The equipment for navigation, manoeuvring, supervision and data transmission and other appliances with an important role in the operation of

the vessel shall be placed sufficiently close together to enable a second crew member while seated to have access to the necessary data and to make use as the need arises of control equipment and installations.

22B-5.3 The helmsman and a second crew member shall be able to control the equipment referred to in paragraph 22B-5.2 without hindrance, including when seated wearing correctly fastened seat belts.

22B-5.4 The steering station shall be so designed as to conform to paragraphs 7-6.1 to 7-6.7.

22B-5.5 Whatever the laden state, the blind area of vision forward of the bow from a seated position shall not be greater than the length of the vessel. When the blind area of vision exceeds the length of the vessel, a table indicating the length of the blind area and the time of crossing it, depending on the speed of the vessel, shall be located in the wheelhouse at a clearly visible place.

22B-5.6 The total arc of blind sectors from right ahead to 22.5° abaft the beam on either side shall not exceed 20°. Each individual blind sector shall not exceed 5°. The clear sector between two blind sectors shall not be less than 10°.

22B-5.7 Windows shall be designed to minimize unwanted reflections. Installations to prevent dazzling by the sun shall be provided.

22B-5.8 Surface materials used in the wheelhouse shall avoid reflections.

22B-6 SAFETY INFORMATION

22B-6.1 All passenger vessels shall be equipped with means of providing acoustic and visual information on safety measures that are audible and visible to all passengers.

22B-6.2 The means referred to in paragraph 22B-6.1 shall enable the master to give instructions to the passengers.

22B-6.3 In the vicinity of each passenger seat there shall be instructions concerning emergency situations, including in particular an overall sketch of the vessel on which are marked all the exits, evacuation routes, emergency and rescue equipment and containing instructions on the use of life-jackets.

22B-7 EXITS AND EVACUATION ROUTES

22B-7.1 An easy, safe and rapid access shall be ensured from the wheelhouse to the spaces and accommodation accessible to the public.

22B-7.2 The evacuation routes leading to the safety exits shall be indicated clearly and permanently.

22B-7.3 All concealed exits shall be adequately indicated. The means of operating the opening mechanisms of exit doors shall be clearly visible from the outside and from the inside.

22B-7.4 An adequate space shall be provided beside the exits for a crew member.

22B-8 FIRE PROTECTION

22B-8.1 Corridors, spaces and accommodation accessible to the public, galleys and engine rooms shall be connected to an efficient fire alarm system. Any outbreak of fire and its location shall be automatically communicated to a point permanently occupied by members of the crew.

22B-8.2 The following installations are prohibited on board high-speed vessels:

- (i) appliances with wick burners;
- (ii) vaporizing oil-burner stoves;
- (iii) solid fuel heating appliances;
- (iv) liquefied gas installations.

22B-9 ADDITIONAL REQUIREMENTS

Spaces and accommodation accessible to the public and their equipment shall be so designed as to ensure that persons making normal use of them cannot be injured during a normal start or stop, an emergency start or stop or during manoeuvres and under normal sailing conditions, particularly in the event of a breakdown or the erroneous activation of a control.

CHAPTER 23 CREWS

23-1 GENERAL

23-1.1 These Recommendations apply to all inland navigation vessels engaged in international shipping, except unmanned pushed barges and small craft within the meaning of the European Code for Inland Waterways (CEVNI).

23-1.2 Minimum crews on board inland navigation vessels shall conform to the requirements of these recommendations for all operating modes. The recommendations do not preclude competent authorities from prescribing any additional personnel which may be needed in special cases such as the transport of dangerous goods.

23-1.3 The minimum crew prescribed for the operating modes shall be on board the vessel at all times when it is under way. No departure shall be permitted without the prescribed minimum crew.

23-2 CREW MEMBERS

23-2.1 The minimum crew of a vessel, ensuring the safety of its operation, may consist of the following crew members:

- (i) Boatmasters;
- (ii) Helmsmen;
- (iii) Able crewmen;
- (iv) Ordinary crewmen;
- (v) Engineers;
- (vi) Electrician-engineers;
- (vii) Engine-minders;
- (viii) Radio operators. ^{5/}

23-2.2 On inland waterways, where national or international legislation so allows, the minimum crew of vessels, ensuring the safety of its operation may also include apprentices and deck-hands.

23-2.3 The qualifications for crew members shall be as follows:

23-2.3.1 Boatmaster:

Shall hold a boatmaster's licence issued in accordance with the Recommendations on Minimum Requirements for the Issuance of Boatmaster's Licences in Inland Navigation with a view to their Reciprocal Recognition for International Traffic (resolution No. 31 of 12 November 1992).

23-2.3.2 Helmsman:

Shall be not less than 17 years of age and

- (i) shall have had not less than one year's experience in inland navigation as an able crewman or not less than three years' experience as an ordinary crewman within the meaning of 23-2.3.4 (ii), or

^{5/} In accordance with the national rules of the Russian Federation and Ukraine only.

- (ii) shall have successfully completed training provided the training includes experience in inland navigation as a helmsman-apprentice or as an ordinary crewman for a period determined by the competent authority.

23-2.3.3 Able crewman:

- (i) shall have had not less than one year's experience in inland navigation as an ordinary crewman and
 - have successfully completed the training referred to in 23-2.3.5 below, or
 - have passed the final examination of a professional college of inland navigation, or
 - have passed any other examination for ordinary crewman recognized by the competent authority, or
- (ii) shall have successfully completed training referred to in 23-2.3.5 below of a duration of not less than three years or have passed a final examination following training of not less than three years in a professional college of inland navigation provided the training includes not less than one year's experience in inland navigation, or
- (iii) shall have had not less than two years' experience in inland navigation as an ordinary crewman within the meaning of 23-2.3.4 (ii).

23-2.3.4 Ordinary crewman:

- (i) shall be not less than 17 years of age and
 - have passed an examination on completion of the training referred to in 23-2.3.5 below, or
 - have passed an examination on completion of training in a professional college of inland navigation, or
 - have passed any other examination for ordinary crewman recognized by the competent authority, or
- (ii) shall have had not less than three years' experience as a member of the ship's deck department, including not less than one year in inland navigation and two years either in inland navigation or at sea, in coastal navigation or fishing.

23-2.3.5 Apprentice:

Shall be not less than 15 years^{6/} of age and have an apprentice's contract which provides for attendance at a professional college of inland navigation or for a correspondence course approved by the competent authority to be taken in the preparation of an equivalent diploma.

23-2.3.6 Deck-hand:

Shall be not less than 16 years of age.

^{6/} The age limitation of an apprentice may be higher depending on national legislation.

23-2.3.7 Engineer:

- (i) Shall be at least 18 years of age and have passed an examination on completion of a full training course in the engine and mechanics sectors, or
- (ii) Shall have worked for not less than two years as an engine-minder on a motorized inland navigation vessel.

23-2.3.8 Electrician-engineer:

- (i) Shall be at least 18 years of age and have passed an examination on completion of a full training course in on-board electrical systems; or
- (ii) Shall be at least 18 years of age and have experience of working in a ship's crew for a period determined by the competent authority.

23-2.3.9 Engine-minder:

Shall be not less than 17 years of age and either

- (i) be an ordinary crewman and have passed an engine-minder's examination recognized by the competent authority, or
- (ii) have had not less than one year's experience on board a motorized inland navigation vessel as an ordinary crewman and have a basic knowledge of engines.

23-2.3.10 Radio operator

Shall be at least 18 years of age, have passed an examination on completion of a full training course in on-board radio systems and have navigational experience as part of a vessel crew for a period determined by the competent authority, or have completed an appropriate probationary period of at least two months' duration aboard inland navigation vessels.

23-3 CREW MEMBERS - PHYSICAL FITNESS

23-3.1 Physical fitness for the job shall be certified by a medical certificate issued on first enlistment as a crew member by a doctor designated by the competent authority.

23-3.2 Physical fitness involves in particular:

- (i) Adequate eyesight and hearing;
- (ii) The capacity to lift a weight of 20 kg unaided. ^{7/}

23-3.3 Certification of fitness in accordance with 23-3.1 and 23-3.2 above shall be renewed periodically in accordance with the requirements of the Administration.

23-3.4 Where a competent authority has doubts as to the physical fitness of a crew member, it may request a medical examination in accordance with the provisions of 23-3.1 and 23-3.2.

^{7/} The competent authority may waive this requirement or prescribe additional requirements with regard to physical fitness.

23-4 PROOF OF QUALIFICATIONS - SERVICE RECORD

23-4.1 Every member of the minimum crew shall have a personal service record conforming to the model reproduced in the appendix 5 to these Recommendations. All the essential information required in the service record should be printed as a minimum, in the official language of the country concerned and either in French, German or Russian. On enlistment, the service record shall be presented to the boatmaster and kept up to date and carefully preserved by him until discharge. The service record shall be returned to the holder on request at any time and without delay.

The service record contains general information such as diplomas obtained, medical certificates and the holder's qualifications under section 23-2, as well as specific information concerning voyages made or positions held during service on board vessels.

23-4.2 The holder of the service record shall have the record certified at least once in the course of the 12-month period following the date of issue by a competent local authority.

23-4.3 The authority referred to in 23-4.2 above shall be responsible for entering the general information referred to in 23-4.1 above. The boatmaster shall be responsible for entering the specific information referred to in 23-4.1 above. The particulars concerning the preceding voyage shall be entered before the start of the next voyage. The instructions concerning the keeping of the service record and the definitions (e.g. "voyage", start and finish) are to be found in the service record.

23-4.4 For crew members holding a boatmaster's licence in accordance with the Recommendations on Minimum Requirements for the Issuance of Boatmaster's Licences in Inland Navigation with a view to their Reciprocal Recognition for International Traffic (Resolution No. 31 of 12 November 1992), such licence shall stand in lieu of the service record.

23-4.5 It shall be possible to provide proof of qualification for employment on board at any time:

23-4.5.1 for the boatmaster, in the form of the boatmaster's licence;

23-4.5.2 for the helmsman, able crewman, ordinary crewman, engineer or engine-minder in the form of the service record or the boatmaster's licence.

23-4.6 For crew members who hold a licence or proof of qualifications and appear on the crew list in accordance with national regulations of the country the waterways of which they navigate, such licences and proof of qualifications shall stand in lieu of the service record provided that the service record is not prescribed by national or international law concerning the navigation on inland waterways they navigate.

23-5 OPERATING MODES ^{8/}

A distinction shall be made between the following operating modes:

| | | | |
|----------------|--|---|-----------------------|
| A ₁ | daytime navigation for a maximum of 14 hours ^{9/} | } | per 24-hour period |
| A ₂ | semi-continuous navigation for not more than 18 hours | | |
| B | continuous navigation for 24 hours and more | | |

A vessel navigating under mode A₁ or mode A₂ shall cease navigation for 8 hours continuously, in the former case, and 6 hours continuously, in the latter case, if the vessel is equipped with a tachograph of a type approved by the Administration and in proper working order. In the other cases, a vessel sailing under mode A₁ shall cease navigation for the whole of the period between 10 p.m. and 6 a.m., and a vessel under mode A₂ between 11 p.m. and 5 a.m.

23-6 MANDATORY REST PERIOD

23-6.1 In operating mode A₁, all members of the crew shall have eight hours of uninterrupted rest outside sailing time for each 24-hour period, calculated from the end of each 8-hour rest period.

In operating mode A₂, all crew members shall have eight hours' rest including six hours uninterrupted rest time outside sailing times ^{10/} for each 24-hour period, calculated from the end of each 6-hour rest period.

In operating mode B, all crew members shall have 24 hours' rest time per 48-hour period including at least two 6-hour periods of uninterrupted rest.

During the mandatory rest time, a crew member may not be called on to perform any duty, including surveillance or standby; the watch and surveillance duties provided for in the European Code for Inland Waterways (CEVNI) for stationary vessels shall not be considered as an obligation under this paragraph.

23-6.2 The provisions of labour regulations and in collective agreements concerning longer rest periods shall remain valid.

23-7 CHANGE OR REPETITION OF OPERATING MODE

23-7.1 A change or repetition of operating mode may take place only if the following requirements are complied with:

- (i) The change-over from operating mode A₁ to mode A₂ may take place only if:
 - the crew has been entirely replaced, or
 - the crew members required for operating mode A₂ have completed, immediately prior to the change, an 8-hour rest period, including six hours outside sailing-time, and the extra crew required for operating mode A₂ are on board.

^{8/} On certain river basins competent authorities may prescribe operating modes which differ from those indicated in section 23-5.

^{9/} Daytime navigation may be extended to a maximum of 16 hours, not more than once a week, if the vessel is equipped with a tachograph approved by the Administration and in proper working order, and if the members of the minimum crew include one holder of the boatmaster's licence and a helmsman.

^{10/} For all crew members under 18, eight hours of uninterrupted rest including six hours outside sailing times.

- (ii) The change-over from operating mode A2 to mode A1 may take place only if:
 - the crew has been entirely replaced, or
 - the crew members required for operating mode A1 have completed, immediately prior to the change, an uninterrupted rest period of eight hours outside sailing-time.
- (iii) The change-over from mode B to mode A1 or A2 may take place only if:
 - the crew has been entirely replaced, or
 - the crew members required for operating modes A1 and A2 have completed, immediately prior to the change, 8-hour and 6-hour uninterrupted rest periods, respectively.
- (iv) The change-over from operating mode A1 or A2 to mode B may take place only if:
 - the crew has been entirely replaced, or
 - the crew members required for operating mode B have completed, immediately prior to the change, 8-hour and 6-hour uninterrupted rest periods, respectively, outside sailing time and the extra crew required for mode B are on board.

- 23-7.2 A repetition from operating mode A1 or A2 may take place only if:
- the crew has been entirely replaced, and
 - the crew members required for the repeated mode A1 or A2, have completed, immediately prior to the change, 8-hour or 6-hour uninterrupted rest periods respectively, outside sailing time.

23-7.3 In all cases of change of operating mode, the shipowner shall amend the crew manning table in line with the minimum requirements governing crew composition and bring the crew up to strength in accordance with the new manning table prior to changing the operating mode.

23-8 SHIP'S LOG, TACHOGRAPH

23-8.1 A ship's log conforming to the requirements of the Administration shall be kept on board each vessel to which the provisions of present Recommendations apply in accordance with section 23-1 above. The ship's log shall be kept in accordance with the instructions it contains. The responsibility for keeping the ship's log and making the necessary entries in it shall devolve on the boatmaster. The first ship's log, which shall bear the number 1, the name of the vessel and its official number, shall be issued by the authority which issued the ship's certificate.

The beginning and end of rest periods shall be entered each day during the voyage.

The particulars relating to a change of operating mode shall be entered on a fresh page of the ship's log.

23-8.2 Subsequent ship's logs may be issued by a competent local authority which shall affix to them their serial number; however, they may be issued only on production of the preceding log. The preceding log shall be marked indelibly "cancelled" and returned to the boatmaster.

23-8.3 The cancelled log shall be kept on board for six months following the last entry.

23-8.4 On issue of the first ship's log in accordance with 23-8.1, the authority issuing it shall certify that it has done so by means of a certificate indicating the name of the vessel, its official number, the number of the ship's log, and the date of issue. This certificate shall be kept on board and be produced on request. The issue of subsequent ship's logs in accordance with 23-8.2 shall be entered by the competent authority on the certificate.

23-8.5 Tachograph recordings shall be kept on board for six months following the last entry if the vessel is equipped with a tachograph.

23-9 EQUIPMENT OF VESSELS

23-9.1 Notwithstanding the other provisions of these Recommendations, self-propelled vessels, self-propelled pusher vessels, pushers, pushed convoys and passenger vessels operated with a minimum crew shall meet the following requirements:

- (i) The propulsion equipment shall be so arranged as to enable the speed to be changed and the direction of propulsion reversed from the vessel's steering station.
It shall be possible to start and stop the auxiliary machinery required to operate the vessel from the steering station, unless they function automatically or continuously during each voyage.
- (ii) The critical levels of:
 - the temperature of the water for cooling the main engines,
 - the oil pressure of the main engines and transmission gear,
 - the oil and air pressure of the devices for reversing the main engines, the reversible transmission gear or the propellers, and
 - the filling level of the engine room hold shall be indicated by devices which set off sound and visual alarms in the wheelhouse. The sound alarms may be contained in a single sound apparatus and can be stopped once the breakdown has been noted. The visual alarms shall be extinguished only when the relevant problems they indicate have been eliminated.
- (iii) The fuel feed and the cooling of the main engines shall be automatic.
- (iv) It shall be possible for one person to man the helm without special effort even at the maximum authorized draught.
- (v) It shall be possible to initiate the visual and sound signals prescribed by the European Code for Inland Waterways (CEVNI) for vessels under way from the steering station.
- (vi) If direct communication between the steering station and the bow of the vessel, the stern of the vessel, the crew accommodation and the engine room is not possible, a sound link shall be provided. For the engine room, the sound link may be replaced by visual and sound signals.
- (vii) It shall be possible for a single crew member on his own to launch the required ship's boat with due dispatch.
- (viii) A spotlight, which can be manipulated from the steering station, shall be installed on board.
- (ix) The effort required to manipulate cranks and similar pivoting devices for lifting equipment shall not be more than 16 kg.
- (x) The towing winches shall be power-driven.

- (xi) The bilge pumps and the deck swabbing pumps shall be power-driven.
- (xii) The main control devices and monitoring instruments shall be arranged ergonomically.
- (xiii) It shall be possible to control the equipment referred to in paragraph 6-1.1 from the steering station.
- (xiv) The vessel shall be equipped with a VHF radiotelephone for the ship-to-ship and shipping information networks.

23-9.2 The conformity or non-conformity of the vessel with the requirements of 23-9.1 above, shall be certified by a certificate issued by the Administration.

This certificate shall be kept on board the vessel.

23-10 MINIMUM CREW FOR SELF-PROPELLED CARGO VESSELS AND PUSHERS ^{11/}

The minimum crew for self-propelled vessels comprises:

| Length of the vessel L in m | Crew members | Number of crew members for operating mode | | |
|-----------------------------|------------------|---|----------------|------------------|
| | | A ₁ | A ₂ | B |
| L ≤ 70 | boatmaster | 1 | 2 | 2 |
| | helmsman | - | - | - |
| | able crewman | - | - | - |
| | ordinary crewman | 1 | - | 2 |
| 70 < L ≤ 86 | boatmaster | 1 | 2 | 2 |
| | helmsman | - | - | - |
| | able crewman | 1 | - | - |
| | ordinary crewman | - | 1 | 2 |
| L > 86 | boatmaster | 1 | 2 | 2 |
| | helmsman | 1 | - | 1 |
| | able crewman | - | - | - |
| | ordinary crewman | 1 | 2 | 2 ^{12/} |

^{11/} The competent authorities may permit different composition of a minimum crew in terms of categories of posts, with the exception of a number of boatmasters which should not be below the level stipulated in this section. Whatever is the composition of the minimum crew, its total number and qualifications should not be below the levels stipulated in this section. Notwithstanding the above, on inland waterways, where national or international legislation so allows, one or more of the ordinary crewmen may be replaced by apprentices or deckhands.

^{12/} If the helmsman is replaced by a third boatmaster, one ordinary crewman shall be enough.

23-11 MINIMUM CREW FOR PUSHERS, SELF-PROPELLED PUSHER VESSELS, PUSHED CONVOYS, SIDE-BY-SIDE FORMATIONS AND OTHER RIGID FORMATIONS ^{13/}

23-11.1 The minimum crew for pushers, pushed convoys, side-by-side formations and other rigid formations comprises:

| Type of convoy | Crew members | Number of crew members for operating mode | | |
|---|---|---|-----------------------|--------------------------------------|
| | | A ₁ | A ₂ | B |
| pusher + one pushed barge ^{14/} or formation with the dimensions: L ≤ 116.5 m B ≤ 15 m | boatmaster helmsman able crewman ordinary crewman engineer or engine-minder | 1 1 - 1 - | 2 - - 2 - | 2 1 - 2 ^{15/} - |
| pusher + two pushed barges or self-propelled vessel +one pushed barge | boatmaster helmsman able crewman ordinary crewman engineer or engine-minder | 1 1 - 2 - | 2 - - 3 - | 2 1 - 2 1 ^{16/} |
| pusher + three or four pushed barges or self-propelled vessel + two or three pushed barges | boatmaster helmsman able crewman ordinary crewman engineer or engine-minder | 1 1 - 2 1 | 2 - - 3 1 | 2 1 - 3 ^{17/} 1 |
| pusher + more than four pushed barges | boatmaster helmsman able crewman ordinary crewman engineer or engine-minder | 1 1 - 3 1 | 2 - - 4 1 | 2 1 - 4 ^{18/} 1 |

23-11.2 The competent authority may prescribe different manning requirements for convoys with a length of up to 82 m and a width of 11.45 m.

23-11.3 In the case of pushed barges or towed barges, one ordinary crewman is included for every two pushed barges or towed barges.

^{13/} The competent authorities may permit different composition of a minimum crew in terms of categories of posts, with the exception of a number of boatmasters which should not be below the level stipulated in this section. Whatever is the composition of the minimum crew, its total number and qualifications should not be below the levels stipulated in this section. Notwithstanding the above, on inland waterways, where national [or international] legislation so allows, one or more of the ordinary crewmen may be replaced by apprentices or deckhands.

^{14/} The term "pushed barge(s)" refers to a standard Europe II pushed barge or its equivalent in terms of length (76.5m):

1 pushed barge = 2 pushed barges with a length > 25.50m and ≤ 38.25 m each (e.g. Likes barges);

1 pushed barge = 3 pushed barges with a length > 19.12m and ≤ 25.50 m each (e.g. Barko Liner barges);

1 pushed barge = 4 pushed barges with a length ≤ 19.12m each (e.g. Lash barges).

^{15/} If the helmsman is replaced by a third boatmaster, one ordinary crewman shall be enough.

^{16/} If the helmsman is replaced by a third boatmaster the crew may not need to include an engineer or an engine-minder.

^{17/} If the helmsman is replaced by a third boatmaster two ordinary crewmen shall be enough.

^{18/} If the helmsman is replaced by a third boatmaster three ordinary crewmen shall be enough.

23-12 MINIMUM CREW FOR PASSENGER VESSELS ^{19/}

23-12.1 The minimum crew for passenger vessels for day excursions comprises:

| Maximum permitted number of passengers | Crew members | Number of crew members for operating mode | | |
|--|----------------------------------|---|----------------|---|
| | | A ₁ | A ₂ | B |
| up to 75 persons | boatmaster | 1 | 2 | 2 |
| | helmsman | - | - | - |
| | able crewman | - | - | - |
| | ordinary crewman | 1 | 1 | 2 |
| | engineer or engine-minder | - | - | - |
| between 76 and 250 persons | boatmaster | 1 | 2 | 2 |
| | helmsman | - | - | - |
| | able crewman | - | - | - |
| | ordinary crewman | 2 ^{20/} | 1 | 2 |
| | engineer or engine-minder | - | 1 | 1 |
| between 251 and 600 persons | boatmaster | 1 | 2 | 3 |
| | helmsman | - | - | - |
| | able crewman | 1 | - | - |
| | ordinary crewman | - | 1 | 1 |
| | engineer or engine-minder | 1 | 1 | 1 |
| between 601 and 1 000 persons | boatmaster | 1 | 2 | 3 |
| | helmsman | 1 | - | - |
| | able crewman | - | - | - |
| | ordinary crewman | 2 | 2 | 2 |
| | engineer or engine-minder | 1 | 1 | 1 |
| more than 1 000 persons | boatmaster | 2 | 2 | 3 |
| | helmsman | - | - | - |
| | able crewman | - | - | - |
| | ordinary crewman | 3 | 4 | 4 |
| | engineer or engine-minder | 1 | 1 | 1 |

23-12.2 The minimum crew for steamboats for day excursions should be increased by one engineer in all operating modes.

^{19/} The competent authorities may permit different composition of a minimum crew in terms of categories of posts, with the exception of a number of boatmasters which should not be below the level stipulated in this section. Whatever is the composition of the minimum crew, its total number and qualifications should not be below the levels stipulated in this section. Notwithstanding the above, on inland waterways, where national or international legislation so allows, one or more of the ordinary crewmen may be replaced by apprentices or deckhands.

^{20/} Both ordinary crewmen may be replaced by one engineer or an engine-minder.

23-12.3 The minimum crew for passenger cabin vessels comprises ^{21/}:

| Group according to the number of berths | Crew members | Number of crew members for operating mode | | |
|---|---------------------------|---|----------------|---|
| | | A ₁ | A ₂ | B |
| up to 50 berths | boatmaster | 1 | 2 | 3 |
| | helmsman | - | - | - |
| | able crewman | 1 | - | - |
| | ordinary crewman | - | 1 | 1 |
| | engineer or engine-minder | 1 | 1 | 1 |
| between 51 and 100 berths | boatmaster | 1 | 2 | 3 |
| | helmsman | 1 | - | - |
| | able crewman | - | - | - |
| | ordinary crewman | 1 | 1 | 1 |
| | engineer or engine-minder | 1 | 1 | 1 |
| more than 100 berths | boatmaster | 1 | 2 | 3 |
| | helmsman | 1 | - | - |
| | able crewman | - | - | - |
| | ordinary crewman | 2 | 3 | 3 |
| | engineer or engine-minder | 1 | 1 | 1 |

23-13 MANNING OF VESSELS WHOSE MINIMUM EQUIPMENT REFERRED TO IN SECTION 23-9 IS INCOMPLETE

23-13.1 When the equipment of a self-propelled vessel, pusher, rigid convoy, or other rigid assembly or passenger vessel does not correspond to the standard of equipment required in paragraph 23-9.1, the minimum crew prescribed in sections 23-10, 23-11 or 23-12 shall be increased by:

- (i) one ordinary crewman in operating modes A1 and A2 and
- (ii) two ordinary crewmen in operating mode B. When, however, the requirements of paragraph 23-9.1, letters (ix) and (x) only, or of one of these letters are not met, the crew shall be increased in operating mode B by one ordinary crewman instead of two.

23-13.2 In addition, when one or more of the requirements of paragraph 23-9.1, letters (i) to (iii), are not met,

- (i) the ordinary crewman prescribed in 23-13.1 (i) above shall be replaced by an engine-minder in operating modes A1 and A2 and
- (ii) the two ordinary crewmen prescribed in 23-13.1 (ii) above shall be replaced by two engine-minders in operating mode B.

^{21/} The competent authorities may permit different composition of a minimum crew in terms of categories of posts, with the exception of a number of boatmasters which should not be below the level stipulated in this section. Whatever is the composition of the minimum crew, its total number and qualifications should not be below the levels stipulated in this section. Notwithstanding the above, on inland waterways, where national or international legislation so allows, one or more of the ordinary crewmen may be replaced by apprentices or deckhands.

23-14 MINIMUM CREWS FOR OTHER VESSELS

The Administration shall determine for vessels not mentioned in sections 23-10 to 23-12 but covered by the present Recommendations in accordance with section 23-1 above (e.g. tugs, towed barges, floating equipment, high-speed vessels), according to their dimensions, form of construction, equipment and intended use, what crews shall be on board during navigation.”

**CHAPTER 24
TRANSITIONAL AND FINAL PROVISIONS**

(Left void)

Appendix 1**LIST OF EUROPEAN INLAND WATERWAYS
DIVIDED GEOGRAPHICALLY INTO ZONES 1, 2 AND 3**
(paragraph 1-1.5 of the Recommendations)**CHAPTER I****ZONE 1****GERMANY**

Ems, from a line linking Delfzijl church tower and Knock lighthouse towards the open sea to the parallel of latitude 53°30'N and longitude 6°45'E, i.e. slightly seawards from the lightening place for dry-cargo carriers in the Alte Ems.^{22/}

POLAND

Pomorska Bay, to the south of the line linking the headland of Nord Perd on the Rügen Island and the Niechorze lighthouse.

Gdansk Bay, to the south of the line running from the Hel lighthouse to the Krynica lighthouse.

RUSSIAN FEDERATION

Vygozero.

Volqogradskoe Reservoir, from Uvek bridge to the dam at the Volgograd hydroelectric power station.

Votkinskoe Reservoir, from the Chastye wharf to the dam at the Votkinsk hydroelectric power station.

Kamskoe Reservoir, from Berezniki to the dam at the Kama hydroelectric power station.

Kuybyshevskoe Reservoir, along the Volga river, from the town of Kamskoe Ustye to the dam at the Kuybyshev hydroelectric power station; along the Kama river from Chistopol to Kamskoe Ustye.

Rybinskoe Reservoir, with the exception of the northern section from Cherepovets to Vichelovo.

Tsimlyanskoe Reservoir, from Pyatiizbyan roadsteads to the dam at Tsimlyansk hydroelectric power station.

Volgokaspijskiy Kanal, from buoy 217 (146.0 km) to the Astrakhan lighthouse.

Don, from Azov to the port of Taganrog.

Nizhne-Kamskoe Reservoir, from the town of Ust-Belsk (1766 km) to the dam at the Lower Kama hydroelectric power station;

^{22/} To be applied to ships registered in another country as provided in the Ems-Dollard Treaty, Article 32 of 8 April 1960 (Federal Law Gazette 1963, II, page 602).

Mezen, from the mouth of the Bolshaya Chetsa River to the Mezen entrance buoy.

Pechora, from the Alekseevsky Island to the line between the Cape of Bolvansky Nos – northern extremity of the Lovetsky Island.

Northern Dvina – along the Maymaksan branch from the village of Lapominka to the southern extremity of the Mudiug Island, along the Murmansk branch to the Kumbysh Island.

UKRAINE

Dniprobuzkiy Lyman, up to the Port of Ochakiv.

Pivdenny Buh, downstream of Mykolaiv sea port.

Kakhovske reservoir, from the dam of Kakhovska Hydro-electric Plant to Bilenka wharf (180 km).

Kremenchuzke Reservoir, from the dam of Kremenchuzka Hydro-electric Plant to the Topylivka village (70 km).

CHAPTER II ZONE 2

CZECH REPUBLIC

Lipno Reservoir.

FRANCE

Dordogne, downstream from the stone bridge at Libourne.

Garonne, downstream from the stone bridge at Bordeaux.

Gironde.

Loire, downstream from Haudaudine bridge on the Madeleine branch and downstream from Pirmil bridge on the Pirmil branch.

Rhône, downstream from Trinquetaille bridge at Arles.

Seine, downstream from Jeanne-d'Arc bridge at Rouen.

GERMANY

Ems: from a line across the river Ems near the entrance to Papenburg harbour between Diemer Schöpfwerk and the opening of the dyke at Halte as far as a line linking Delfzijl church tower and Knock lighthouse.^{23/}

Jade, inside a line linking the Schillighörn upper range light and Langwarden church tower.

^{23/} To be applied to ships registered in another country as provided in the Ems-Dollard Treaty, Article 32 of 8 April 1960 (Federal Law Gazette 1963, II, page 602).

Weser, from the Bremen railway bridge to a line linking Langwarden and Cappel church towers with the side branches: Westergate, Rekumer Loch, Rechter Nebenarm and Schweiburg.

Elbe, from the lower limit of the port of Hamburg to a line linking the Döse beacon and the north-western point of the Hohes Ufer (Dieksand) with the Nebeloben as well as the tributaries: Este, Lühe, Schwinge, Oste, Pinnau, Krückau and Stör (in each case from the barrage to the mouth).

Meldorfer Bucht, inside a line linking the north-western point of the Hohes Ufer (Dieksand) and Büsum west pier head.

Eider, from the Gieselau Canal to the Eider barrage.

Flensburger Förde, inside a line linking Kekenis lighthouse and Birknack

Schlei, inside a line linking the Schleimünde pier heads.

Eckernförder Bucht, inside a line linking Boknis-Eck to the north-eastern point of the mainland near Dänisch Nienhof.

Kieler Förde, inside a line linking Bülk lighthouse at the Laboe naval memorial.

Nord-Ostsee-Kanal (Kiel Canal), from the line linking the Brunsbüttel pier heads to a line linking the entrance lights of Kiel-Holtenau including Obereidersee with Enge, Audorfer See, Bergstedter See, Schirnauer See, Flehmuder See and Achterwehrer Schifffahrtskanal.

Trave, from the railway bridge and the Holsten Bridge (Stadttrave) in Lübeck to a line linking the two outer pier heads at Travemünde including the Pötenitzer Wiek and the Dassower See.

Leda, from the entrance to the outer harbour of the Leer sea lock to the mouth.

Hunte, from Oldenburg harbour and from 140 m downstream of the Amalienbrücke in Oldenburg to the mouth.

Lesum, from the Bremen-Burg railway bridge to the mouth.

Este, from downstream Buxtehude lock to the Este barrage.

Lühe, from the mill 250 m upstream from the Marschdamm-Horneburg road bridge to the Lühe barrage.

Schwinge, from the foot-bridge downstream of Guldernstern bastion at Stade to the Schwinge barrage.

Freiburger Hafenspriel, from the Freiburg/Elbe lock to the mouth.

Oste, from the Bremervörde mill dam to the Oste barrage.

Pinnau, from the Pinneberg railway bridge to the Pinnau barrage.

Krückau, from the Elmshorn water mill to the Krückau barrage.

Stör, from the Rensing tide gauge to the Stör barrage.

Wismarbucht, Kirchsee, Breitling, Salzhaff and Wismar port area, limited seawards by a line: Hohen Wieschendorf Huk and Timmendorf light as well as Gollwitz light on the Island of Poel and the southern point of Wustrow Peninsula.

Unterwarnow and Breitling, limited seawards by a line linking the northernmost points of the western, central and eastern piers of Warnemünde.

Waters between the mainland and the Darss and Zingst peninsulas as well as the Hiddensee and Rügen islands (including Stralsund port area), limited seawards between:

the Zingst peninsula and the island of Bock by the parallel of latitude 54°27' N;

the islands of Bock and Hiddensee by a line linking the northern point of the island of Bock and the southern point of the island of Hiddensee;

the island of Hiddensee and the island of Rügen (Bug) by a line linking the south-eastern point of Neubessin to Buger Haken.

Greifswalder Bodden and Greifswald port area including the river Ryck, limited seawards by a line linking the eastern point Thiessower Haken (Südperd) to the eastern point of the island of Ruden and further to the northern point of the island of Usedom (54° 10'37" N, 13°47'51" E).

Waters between the mainland and the island of Usedom (Peenestrom including Wolgast port area, Achterwasser, Stettiner Haff), limited in the east by the border between the Federal Republic of Germany and the Republic of Poland in the Stettiner Haff.

NETHERLANDS

Dollard.

Eems.

Waddenzee, including the links with the North Sea.

IJsselmeer, including the Markermeer and the IJmeer but excluding the Gouwzee.

Rotterdam Waterweg and the Scheur.

Hollands Diep.

Harringvliet and Vuile Gat, including the waterways between Goeree-Overflakkee on the one hand and Voorne-Putten and Hoekse Waard on the other.

Hellegat.

Volkerak.

Krammer.

Grevelingenmeer and Brouwershavense Gat, including all the waterways between Schouwen-Duiveland and Goeree-Overflakkee.

Keten, Mastgat, Zijpe Eastern Scheldt and Roompot, including the waterways between Walcheren, Noord-Beveland and Zuid-Beveland on the one hand and Schouwen-Duiveland and Tholen on the other hand, excluding the Scheldt-Rhine Canal.

Scheldt and Western Scheldt and its mouth on the sea, including the waterways between Zeeland Flanders on the one hand and Walcheren and Zuid-Beveland on the other, excluding the Scheldt-Rhine Canal.

Breediep.

Beer Canal and adjacent ports.

Caland Canal, west of Benelux Port.

Krabbenkreek.

POLAND

Oder, from Szczecin to Swinoujscie including the Szczecin Inlet (from the border with Germany) and the Kemienski Inlet.

Zalew Wislany, up to the Polish/Russian border.

Mazury Lake Area covering the Sniardwy, Niegocin and Mamry Lakes.

REPUBLIC OF MOLDOVA

Dubossarskoe Reservoir.

Koshteshtskoe Reservoir.

RUSSIAN FEDERATION

Beloe Lake.

Gorkovskoe Reservoir.

Ivankovskoe Reservoir.

Rybinskoe Reservoir, from Cherepovets to Vichelovo.

Saratovskoe Reservoir, from Syzran bridge to the dam at the Saratov hydroelectric power station.

Uglicheskoe Reservoir.

Sheksninskoe Reservoir.

Don, from Rostov-na-Donu to Azov.

Svir.

Volgo-Donskoj Kanal, from Volgograd to Pyatiizbyanskije roadsteads.

Kanal im. Moskvi, from the Bolshaya Volga wharf to lock No. 7.

Volgo-Kaspijskiy Kanal, from the town of Krasnye Barrikady (0.0 km) to buoy 217 (146.0 km).

Chudskoye Lake.

Ilmen Lake.

Kubenskoye Lake.

Pskovskoye Lake.

Veselovskoe Reservoir.

Krasnodarskoe Reservoir.

Cheboksarskoe Reservoir.

Belaya – from Yamalinsky Yar (1786 km) to the mouth.

Volga - from the city of Tver to the town of Koprino (including Ivankovskoe and Uglichskoe reservoirs), from the dam at the Rybinsk hydro-electric power station to the Elyat mouth, from the dam at the Gorkovskaya hydro-electric power station to the Sura mouth, from the dam at the Cheboksary hydro-electric power station to the village of Kamskoe Ustye, from the dam at the Kuibyshevskaya hydro-electric power station to Syzran bridge, from the dam at the Saratov hydro-electric power station to Uvek bridge, from the dam at the Volgograd hydro-electric power station to the town of Krasnye Barrikady.

Kama - from the dam at the Kama hydro-electric power station to the Chastye wharf, from the dam at the Votkinsk hydro-electric power station to the town of Ust-Belsk (1766 km), from the dam at the Lower Kama hydro-electric power station to Tchistopol.

Mezen - from the city of Mezen to the Bolshaya Chetsa mouth.

Neva - from the source to the border of the inland waterways: along the Bolshaya Neva - Lieutenant Schmidt bridge; along the Malaya Neva - the alignment of the 1st Line of the Vasilyev island; along the Bolshaya Nevka - the alignment of spit of the Elagin island; along the Srednaya Nevka - the upper cape of the mouth of the Chukhonka river (the entrance to the rowing canal); along the Malaya Nevka - Petrovsky bridge.

Northern Dvina - from the Pinega mouth to the Uyma mouth; along the Maymaksan branch from the Uyma mouth to the village of Lapominka; along the Nikolskiy branch and channels between the isles of Yagra, Uglomin and Nikolsky to south-west extremity of the isle of Yagra.

White Sea access canal to the entrance buoy.

Gulfs of Veslinsk and Kaliningrad including the sea port of Kaliningrad and the canal to the line between the ends of the south and north moles of the port of Baltiysk.

Volga-Baltic Canal - from the Onega Lake to the dam at the Sheksna hydroelectric power station including the Sizmin flooding.

Gulf of Kurshsky to the line between the ends of the south and north moles of the entrance gate to the port of Klaipeda.

Nevskaya Guba - from the border of inland waterways to the dam along the line between Gorskaya - Kronshtadt - Oranienbaum;

Petchora, from the village of Ust-Tzilma to the city of Naryan-Mar.

UKRAINE

Dnipro, downstream of the Port of Kyiv (with the exception of areas belonging to zone 1) and the section from the wharf Teremtsy to the dam of Kyiv Hydro-electric Plant.

Pripyat, downstream of Vydoumka wharf.

Pivdenny Buh, from Ternovate village to Mykolaiv sea port.

Dnistrovskiy Lyman.

Dnistrovske Reservoir, from the dam to Dnistrovka village (60 km).

Kakhovske Reservoir, upstream of the Bilenka wharf (180 km).

Dniprovske Reservoir.

Kremenchuzke Reservoir, upstream of Topylivka village (70 km).

Dniprodzerzhynske Reservoir.

Kanivske Reservoir, from the dam of Kanivska Hydro-electric Plant to Novo-Ukrainka wharf.

Kyivske Reservoir, from the dam of Kyivska Hydro-electric Plant to Teremtsy wharf on the Dnipro and to Vydumka wharf on the Pripyat.

Pechenezke Reservoir.

Krasnooskolske Reservoir.

Burshtynske Reservoir.

Svitiaz Lake.

CHAPTER III ZONE 3

AUSTRIA

Danube.

BELARUS

Dnepr, from the mouth of the Leshch river to the Lyubech wharf.

Neman, from Mosta to the frontier with Lithuania.

Pripyat, from the Stakhovo lock to the frontier with the Ukraine.

Zapadnaja Dvina, from the mouth of the Usvyacha river to V. Dvinsk.

Sozh, from Grodno to the mouth.

Berezina, from Borisov to the mouth.

Dneprovsko-Bugskiy Kanal, from Brest to the Stakhovo lock.

Mikashevicheskiy Kanal, from Mikashevichi to the Pripyat river.

BELGIUM

Maritime Scheldt (downstream of Antwerp open anchorage).

BULGARIA

Danube.

CROATIA

Danube.

CZECH REPUBLIC

Elbe, from Lovosice lock to Usti nad Labem lock.

FRANCE

Rhine.

GERMANY

Danube, from Kelheim (2,414.72 km) to the German/Austrian border.

Rhine, from the German/Swiss border to the German/Netherlands border.

Elbe, from the mouth of the Elbe-Seitenkanal to the lower limit of the port of Hamburg.

Müritz.

HUNGARY

Danube.

NETHERLANDS

Rhine.

Sneekermeer.

Koeverdmeer.

Heegermeer.

Fluessen.

Slotermeer.

Tjeukemeer.

Beulakkerwijde.

Belterwijde.

Ramsdiep.

Ketelmeer.

Zwartemeer.

Veluwemeer.

Eemmeer.

Alkmaardermeer.

Gouwzee.

Buiten IJ.

Afgesloten IJ.

Noordzeekanaal.

Port of IJmuiden.

Rotterdam port area.

Nieuwe Maas.

Noord.

Oude Maas.

Beneden Merwede.

Nieuwe Merwede.

Dordtsche Kil.

Boven Merwede.

Waal.

Bijlandsch Canal.

Boven Rijn.

Pannersdensch Canal.

Geldersche IJssel.

Neder Rijn.

Lek.

Amsterdam-Rhine Canal.

Veerse Meer.

Scheldt-Rhine Canal as far as the mouth in the Volkerak.

Amer.

Bergsche Maas.

Meuse, downstream from Venlo.

Gooimeer.

Europoort.

Caland Canal, east of Benelux Port.

Hartel Canal.

POLAND

Oder, upstream of Szczecin, except for the section from 704.1 kilometres to 542.4 kilometres, which forms the State border between Germany and Poland.

Western Oder, upstream of Szczecin to the State border between Germany and Poland (17.1 kilometres).

East-West waterway (rivers Warta, Notec, Brda, and Bydgoski Canal)

Vistula.

REPUBLIC OF MOLDOVA

Dnestr.

Prut, from the Koshteshtskaia hydroelectric power station to the mouth.

ROMANIA

Danube.

RUSSIAN FEDERATION

Belomorsko-Baltiyskiy Kanal.

Severnaja Dvina, from its uppermost navigable point to the mouth of the Pinega River.

Pechora, from its uppermost navigable point to Oust-Tsylma.

Volga, from its uppermost navigable point to Tver.

Kama - from the upper reaches to the city of Berezniki.

Manych - from the dam at Veselovsk reservoir to the mouth.

Mezen - from the upper reaches to the city of Mezen.

Oka (tributary of the Volga) - from the upper reaches to the mouth.

Belaya - from the upper reaches to Yamalinsky Yar (1786 km).

Don - from the upper reaches to Piatizbiansk roadsteads and from the dam at the Tsymliansk hydroelectric power station to Rostov-on-Don.

Voronezhskoe Reservoir.

Lakes, rivers and canals other than those mentioned in this appendix.

SERBIA

Danube.

SLOVAKIA

Danube.

SWITZERLAND

Rhine, from Rheinsfelden to Niffer (Kembs).

UKRAINE

Dnipro, upstream of Teremtsy wharf and the section from the Port of Kyiv to the dam of Kyiv Hydro-electric Plant and the Stariy Dnipro Arm (beyond the Khortytsa Lake).

Pripyat, from the mouth to the Belarus/Ukraine frontier.

Desna and other tributaries of the Dnipro.

Pivdenny Buh, upstream of Ternovate village.

Dnister, upstream of Dnistrovka village.

Danube.

Ladyzhynske Reservoir.

Dnistrovske Reservoir, from Dnistrovka village (60 km from the dam) to Vylkhovtsy village (190 km from the dam).

Other inland waterways not mentioned as belonging to zones 1 and 2.

Appendix 2

MODEL SHIP'S CERTIFICATE
(paragraph 2-1.2 of the Recommendations)

SHIP'S CERTIFICATE

(Reserved for State emblem)
NAME OF STATE / SEAL OF STATE

CERTIFICATE No

Place, date

.....

Competent authority on inspection of vessels

.....

Seal

.....

(Signature)

Remarks:

The vessel may be used for navigation by virtue of this certificate only while in the condition herein described. In the event of major alterations or repairs, the vessel must undergo a special inspection before any new voyage. The owner of the vessel, or his representative, must inform a competent authority on inspection of vessels of any change in the name or ownership of the vessel, any remeasurement and any change in the official number, registration number or home port, and send it the ship's certificate for amendment.

Certificate N° of the Competent authority on inspection of vessels

| | | |
|---|----------------------------------|--------------------|
| 1. Name of vessel | 2. Type of vessel | 3. Official number |
| 4. Name and domicile of owner | | |
| 5. Place of registration and registration number | 6. Home port | |
| 7. Year of construction | 8. Name and location of shipyard | |
| 9. This certificate replace Certificate No. _____ issued on _____ by the _____ Competent authority on inspection of vessels. | | |
| <p>10. The above-mentioned vessel, subsequent to the inspection carried out on *) _____ on presentation of the certificate issued on *) _____ by the recognised Classification Society _____ is acknowledged as fit to operate - on waterways in zone(s) (*) _____ _____ on the waterways in zone(s) (*) _____ _____ in ... (Names of States (*)) _____ except for: _____ _____ - on the following waterways in: (Names of the State (*)) _____ _____ _____ at the maximum authorized draught with the rigging specified below.</p> | | |
| 11. The validity of this certificate expires on _____ | | |
| <p>*) Amendment to item(s): _____ New text: _____ _____</p> <p>*) This page has been replaced. Place, date _____ Competent authority on inspection of vessels _____ Seal _____ _____ Signature</p> | | |
| *) Delete as appropriate | | |

Certificate N° of the Competent authority on inspection of vessels

12. The certificate number (1), official number (2), registration number (3) and measurement number (4) are affixed with the corresponding signs at the following locations on the vessel.

- 1 _____
 2 _____
 3 _____
 4 _____

13. The maximum authorized draught is indicated on each side of the vessel.

- by two - _____ - draught marks *)
 - by the upper measurement plates *).

Two draught scales have been applied *).

The rear measurement scales serve as draught scales: they have been supplemented for that purpose by figures indicating the draughts *).

14. Without prejudice to the restrictions*) mentioned in items 15 and 52, the vessel is fit to

- | | |
|--|---|
| 1. push*) | 4. be propelled in a side-by-side formation*) |
| 1.1 in rigid formation*) | 5. tow*) |
| 1.2 with controlled articulation*) | 5.1 vessel having no motive power of its own*) |
| 2. be pushed*) | 5.2 motorized vessel*) |
| 2.1 in rigid formation*) | 5.3 upstream only*) |
| 2.2 at the head of a rigid formation*) | 6. be towed*) |
| 2.3 with controlled articulation*) | 6.1 as a motorized vessel*) |
| 3. propel a side-by-side formation*) | 6.2 as a vessel with no motive power of its own*) |

*) Amendment to item(s): _____

New text: _____

*) This page has been replaced.

Place, date _____

Competent authority on inspection of vessels

Seal

Signature

*) Delete as appropriate

Certificate N° of the Competent authority on inspection of vessels

15. Authorised formations

1. The vessel is authorised to propel the following formations:

| For- mation figure | Restrictions resulting from chapters 5 and 16 | | | | | | | | Remarks |
|--------------------------|---|---------|--------------------------------------|-------|------------|-------|---|------------|---------|
| | Max dimensions m | | Navigation direction and load status | | | | Maximum wetted section in m ² | | |
| | length | breadth | UPSTREAM | | DOWNSTREAM | | upstream | downstream | |
| No. | length | breadth | loaded t | empty | loaded t | empty | upstream | downstream | |
| | | | | | | | | | |
| | | | | | | | | | |
| | | | | | | | | | |
| | | | | | | | | | |
| | | | | | | | | | |
| | | | | | | | | | |
| | | | | | | | | | |
| | | | | | | | | | |
| | | | | | | | | | |
| | | | | | | | | | |
| | | | | | | | | | |
| | | | | | | | | | |
| | | | | | | | | | |
| | | | | | | | | | |

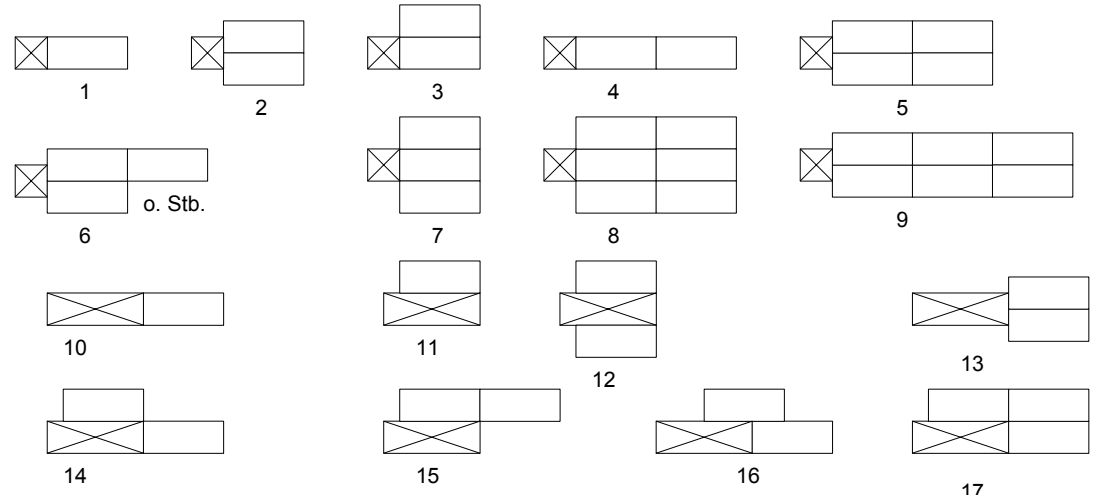

Other formations :



2. Couplings:

Type of coupling: _____ Number of couplings per side: _____
 Number of coupling cables: _____ Length of each coupling cable: _____
 Breaking strain per longitudinal coupling: _____ kN Number of cable windings: _____
 Breaking strain per coupling cable: _____ kN

*) Amendment to item(s): _____
 New text: _____

*) This page has been replaced.
 Place, date _____ Competent authority on inspection of vessels

Seal

Signature

*) Delete as appropriate

Certificate N° of the Competent authority on inspection of vessels

| | | | |
|--|---|---|---------------|
| 16. Measurement certificate No. _____ of the _____ Measurement Office dated _____ | | | |
| 17a. Length overall | m | 18a. Breadth overall | m |
| 17b. Length L | m | 18b. Breadth B | m |
| 19. Maximum draught | | m | 20. Freeboard |
| | | | cm |
| 21. Dead weight/Displacement*) t/m ³ *) | | 22. Number of passengers: | |
| | | 23. Number of passenger berths: | |
| 24. Number of watertight compartments | | 25. Number of holds | |
| | | 26. Type of hatch cover | |
| 27. Number of main propulsion engines | | 28. Total power rating of main means of propulsion kW | |
| | | 29. Number of main propellers | |
| 30. Number of bow windlasses of which powered | | 31. Number of stern windlasses of which powered | |
| 32. Number of towing hooks | | 33. Number of towing winches of which powered. | |
| 34. Steering gear | | | |
| Number of rudder blades on main rudder | | Main rudder drive | |
| | | - manual *) | |
| | | - electric *) | |
| Other installations: yes / no *) | | Type: | |
| Flanking rudder: yes / no *) | | Flanking rudder drive: | |
| | | - manual *) | |
| | | - electric *) | |
| Bow rudder installation yes / no *) | | - bow rudder *) | |
| | | - bow thrusters *) | |
| | | - other installation *) | |
| - Remote control yes / no *) | | - Remote activation yes / no *) | |
| 35. Bilge pumping and draining equipment | | | |
| Total calculated capacity | | Number of power-driven bilge pumps | |
| Pumping capacity | | Number of hand pumps | |
| l/min | | l/min | |
| *) Amendment to item(s): _____ New text: _____ _____ | | | |
| *) This page has been replaced. Place, date _____ Competent authority on inspection of vessels _____ | | | |
| Seal | | Signature | |
| _____ | | _____ | |
| *) Delete as appropriate | | | |

Certificate N° of the Competent authority on inspection of vessels

36. Number and position of closing devices referred to in 8B-1.5

37. Anchors

Number of bow anchors

Total mass of bow anchors
..... kg

Number of stern anchors

Total mass of stern anchors
..... kg

38. Anchor chains

Number of bow anchor chains

Length of each chain
..... m

Tensile strength of each chain
..... kN

Number of stern anchor chains

Length of each chain
..... m

Tensile strength of each chain
..... kN

39. Mooring cables

1st cable m long with a tensile strength kN.

2nd cable m long with a tensile strength kN.

3rd cable m long with a tensile strength kN.

40. Towing cables

..... with a length of m and a tensile strength of kN.

..... with a length of m and a tensile strength of kN.

41. Visual and audible signals

The lights, flags, balls, floats and audible warning devices used for signalling and to emit the visual and audible signals prescribed by the European Code for Inland Waterways (CEVNI) are carried on board, as are the stand-alone emergency mooring lights prescribed by CEVNI.

*) Amendment to item(s):

New text:

*) This page has been replaced.

Place, date Competent authority on inspection of vessels

Seal

Signature

*) Delete as appropriate

Certificate N° of the Competent authority on inspection of vessels

| | | |
|---|--|---|
| <p>42. Other equipment</p> <p>heaving line gangway with handrail</p> <p>gaff hook first-aid kit</p> <p>pair of binoculars notice concerning rescue of persons overboard fire-resistant receptacles embarkation stairway/ladder*)</p> | <p>Voice communi- cation system</p> <p>Radio-telephone installation</p> <p>-</p> <p>Cranes</p> | <p>- alternative two-way*) - simultaneous two-way/telephone*) - internal radio-telephone link*) - vessel-to-vessel service - nautical information service - vessel-port authority service</p> <p>- in accordance with 10-4 *) - cranes with a useful load not exceeding 2000 kg*)</p> |
| <p>43. Fire-fighting appliances</p> | <p>Number of portable extinguishers</p> | <p>Fixed sprinkler system(s) None/Number *) _____</p> <p>Other fixed fire-fighting system(s) None/Number *) _____</p> |
| Number of fire pumps | Number of hydrants | Number of hoses |
| The powered drainage pump replaces a fire pump | | Yes/No *) |
| <p>44. Life-saving equipment</p> <p>Number of lifebuoys _____</p> <p>A life-jacket for each person regularly on board _____</p> <p>Other individual life-saving equipment on passenger vessels *) _____</p> <p>.....</p> <p>.....</p> <p>.....</p> <p>A ship's boat with a set of oars, one mooring line and a baler*) _____</p> <p>Other collective life-saving equipment on passenger vessels *) _____</p> <p>.....</p> <p>.....</p> <p>.....</p> | | |
| <p>45. Special wheelhouse arrangements for steering on radar by one person: Approved for steering on radar by one person *) _____</p> | | |
| <p>*) Amendment to item(s): _____</p> <p>New text: _____</p> <p>.....</p> <p>.....</p> | | |
| <p>*) This page has been replaced.</p> <p>Place, date _____ Competent authority on inspection of vessels</p> <p style="text-align: center;">Seal _____</p> <p style="text-align: right;">Signature _____</p> | | |
| <p>*) Delete as appropriate</p> | | |

Certificate N° of the Competent authority on inspection of vessels

46. The vessel is authorized for operating modes A1^{*)}, A2^{*)}, B^{*)}.

47. Vessel equipment in accordance with 23-9

The vessel (complies)* / (doesn't comply)* with 23-9.1

In accordance with 23-13, the minimum crew should be increased as follows^{*)} / should not be increased^{*)}:

| | Operating mode | | |
|---|----------------|----------------|---|
| | A ₁ | A ₂ | B |
| Ordinary crewman | | | |
| Replacement of the ordinary crewman by an engine-minder | | | |

Observations and special conditions:

.....

48. Minimum crew in accordance with article 23-14

| | Operating mode | | |
|------------------|----------------|----------------|---|
| | A ₁ | A ₂ | B |
| Boatmaster | | | |
| Helmsman | | | |
| Able crewman | | | |
| Ordinary crewman | | | |
| Engineer | | | |
| Engine-minder | | | |

Observations and special conditions:

.....

*) Amendment to item(s):

New text:

.....

*) This page has been replaced.

Place, date

Competent authority on inspection of vessels

Seal

Signature

*) Delete as appropriate

49. Extension/confirmation*) of certificate validity*) Periodical/special*) inspection certificate

The Competent authority on inspection of vessels inspected the vessel on _____ *).

A certificate dated _____ from the _____ Recognised Classification Society

_____ was presented to the Competent authority on inspection of vessels *).

Reason for the inspection / certificate *).

_____ In view of the inspection result / certificate *), the period of validity for the certificate is maintained / extended *) until _____

_____ (Place)

_____ (date)

_____ Seal

_____ Competent authority on inspection of vessels

_____ *) Delete as appropriate

_____ Signature

49. Extension/confirmation*) of certificate validity*) Periodical/special*) inspection certificate

The Competent authority on inspection of vessels inspected the vessel on _____ *).

A certificate dated _____ from the _____ Recognised Classification Society

_____ was presented to the Competent authority on inspection of vessels *).

Reason for the inspection / certificate *).

_____ In view of the inspection result / certificate *), the period of validity for the certificate is maintained / extended *) until _____

_____ (Place)

_____ (date)

_____ Seal

_____ Competent authority on inspection of vessels

_____ *) Delete as appropriate

_____ Signature

49. Extension/confirmation*) of certificate validity*) Periodical/special*) inspection certificate

The Competent authority on inspection of vessels inspected the vessel on _____ *).

A certificate dated _____ from the _____ recognised Classification Society

_____ was presented to the Competent authority on inspection of vessels *).

Reason for the inspection / certificate *).

_____ In view of the inspection result / certificate *), the period of validity for the certificate is maintained / extended *) until _____

_____ (Place)

_____ (date)

_____ Seal

_____ Competent authority on inspection of vessels

_____ *) Delete as appropriate

_____ Signature

49. **Extension/confirmation*) of certificate validity*) Periodical/special*) inspection certificate**

The Competent authority on inspection of vessels inspected the vessel on _____ *).

A certificate dated _____ from the _____ recognised Classification Society

_____ was presented to the Competent authority on inspection of vessels *).

Reason for the inspection / certificate *).

_____ In view of the inspection result / certificate *), the period of validity for the certificate is maintained / extended *)

until _____ .

_____ (Place)

_____ (date)

_____ Seal

_____ Competent authority on inspection of vessels

_____ *) Delete as appropriate

_____ Signature

49. **Extension/confirmation*) of certificate validity*) Periodical/special*) inspection certificate**

The Competent authority on inspection of vessels inspected the vessel on _____ *).

A certificate dated _____ from the _____ recognised Classification Society

_____ was presented to the Competent authority on inspection of vessels *).

Reason for the inspection / certificate *).

_____ In view of the inspection result / certificate *), the period of validity for the certificate is maintained / extended *)

until _____ .

_____ (Place)

_____ (date)

_____ Seal

_____ Competent authority on inspection of vessels

_____ *) Delete as appropriate

_____ Signature

49. **Extension/confirmation*) of certificate validity*) Periodical/special*) inspection certificate**

The Competent authority on inspection of vessels inspected the vessel on _____ *).

A certificate dated _____ from the _____ recognised Classification Society

_____ was presented to the Competent authority on inspection of vessels *).

Reason for the inspection / certificate *).

_____ In view of the inspection result / certificate *), the period of validity for the certificate is maintained / extended *)

until _____ .

_____ (Place)

_____ (date)

_____ Seal

_____ Competent authority on inspection of vessels

_____ *) Delete as appropriate

_____ Signature

51. Extension of the attestation relating to the liquefied gas installation

The period covered by the attestation relating to liquefied gas installation(s)

dated _____ is extended until _____

- following the supplementary inspection by the recognised officer _____
- on presentation of the acceptance report dated _____

(Place)

(Date)

Seal

Competent authority on inspection of vessels

(Signature)

51. Extension of the attestation relating to the liquefied gas installation

The period covered by the attestation relating to liquefied gas installation(s)

dated _____ is extended until _____

- following the supplementary inspection by the recognised officer _____
- on presentation of the acceptance report dated _____

(Place)

(Date)

Seal

Competent authority on inspection of vessels

(Signature)

51. Extension of the attestation relating to the liquefied gas installation

The period covered by the attestation relating to liquefied gas installation(s)

dated _____ is extended until _____

- following the supplementary inspection by the recognised officer _____
- on presentation of the acceptance report dated _____

(Place)



(Date)



Seal

Competent authority on inspection of vessels

(Signature)

Appendix 3**SAFETY SIGNS AND SIGNALS TO BE USED
ON BOARD INLAND NAVIGATION VESSELS**

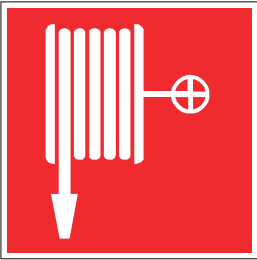
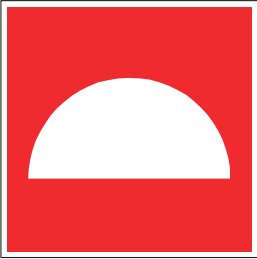
| | | |
|---|--|--|
| <p>Sketch 1</p> <p>No access for unauthorized persons</p> |  | <p><u>Colours:</u> red/white/black</p> |
| <p>Sketch 2</p> <p>No naked lights or fires and no smoking</p> |  | <p><u>Colours:</u> red/white/black</p> |
| <p>Sketch 3</p> <p>Fire-extinguisher panel</p> |  | <p><u>Colours:</u> red/white</p> |
| <p>Sketch 4</p> <p>General danger</p> |  | <p><u>Colours:</u> black/yellow</p> |

| | | |
|---|---|-----------------------------------|
| <p>Fire hose</p> <p style="text-align: right;">Sketch 5</p> |  | <p><u>Colours:</u> red/white</p> |
| <p>Fire extinguishing equipment</p> <p style="text-align: right;">Sketch 6</p> |  | <p><u>Colours:</u> red/white</p> |
| <p>Use ear protectors</p> <p style="text-align: right;">Sketch 7</p> |  | <p><u>Colours:</u> blue/white</p> |

The pictograms used may differ slightly from or be more detailed than those given in this appendix, provided that their meaning is not modified and that the differences and adaptations do not render them incomprehensible.

Administrations may allow using on board vessels additional graphical safety signs and signals which should as much as possible comply with the symbols recommended in the relevant resolutions of the International Maritime Organization and the standards of the International Organization for Standardization.”

Appendix 4**ALTERNATIVE MANOEUVRABILITY TEST PROCEDURES
AND CRITERIA IN ACCORDANCE WITH 5-2.1****I. ALTERNATIVES**

Alternative 1: Administrative Instructions 1 and 2 of Annex II of the European Directive replacing Directive 82/714/EEC as shown below in Addendum 4-1.

Status: This alternative is obligatory on waterways subject to the European Directive replacing Directive 82/714/EEC within the European Union and as far as Member States do not apply derogations according to Annex IV of the above-mentioned Directive, as well as waterways covered by the Revised convention for Rhine navigation of 1868, as amended.

Alternative 2: Requirements set out in section 15, part 1 of the Rules for the Classification and Construction of Inland Navigation Vessels of the Russian River Register, as shown below in Addendum 4-2.

Status: This alternative is obligatory on waterways subject to the Code of Inland Water Transport of the Russian Federation.

Alternative 3: Recommendations concerning the Technical and Navigational Characteristics of Pushed Convoys of the Danube Commission as shown below in Addendum 4-3.

Status: This alternative is a recommendation.

II. ENTRIES ON THE SHIP'S CERTIFICATE IN ACCORDANCE WITH 5-2.2

In accordance with 5-2.2 the Competent authority on the inspection of vessels shall enter into the ship's certificate under item 52 which of the above-mentioned alternatives has been applied for the navigation tests.

III. ADDENDA

Addendum 4-1

**ADMINISTRATIVE INSTRUCTIONS 1 AND 2 OF ANNEX II OF
THE EUROPEAN DIRECTIVE REPLACING DIRECTIVE 82/714/EEC**

ADMINISTRATIVE INSTRUCTION N° 1
IN ACCORDANCE WITH ARTICLE 1.07 OF ANNEX II OF THE DIRECTIVE

Requirements relating to the capacity for evasive action and turning
(Articles 5.09 and 5.10 together with Articles 5.02 (1), 5.03 (1), 5.04 and 16.06)

1. General conditions and conditions relating to the evasive action test

- 1.1 According to article 5.09, vessels and convoys shall be able to take evasive action in good time and the capacity for such action shall be proved by evasive action manoeuvres in the test area referred to in article 5.03. This shall consist of simulated evasive action to port and starboard, under specific conditions in which the limit values of time shall be complied with in order to reach specific turning speeds relative to the evasive action and subsequent correction of course.

The requirements of paragraph 2 shall be satisfied during tests, with a keel clearance equal to at least 20% of the draught, but not less than 0.50 m.

2. Evasive action test procedure and recording of data

(Diagram in annex 1)

2.1 Evasive action shall be performed as follows:

With the vessel or convoy under way at a constant speed of $V_o = 13$ km/h relative to the water, at the start of the manoeuvre (time $t_o = 0$ s, turning speed $r = 0^\circ/\text{min}$, rudder angle $\delta_o = 0^\circ$, selected engine speed kept constant), evasive action to port or starboard is produced by changing the rudder angle. The rudder shall be placed at an angle δ , or the rudder unit at an angle δ in the case of an active rudder, at the start of the manoeuvre, in accordance with the indications given in 2.3. The rudder angle δ (e.g. 20° to starboard) shall be maintained until the value r_1 of the turning speed referred to in 2.2 for the corresponding dimensions of the vessel or convoy is reached. When the turning speed r_1 is reached, the time t_1 should be noted and the rudder set at the same angle on the other side (e.g. 20° to port) so as to complete the evasive action and correct the course, i.e., to reduce the turning speed to $r_2 = 0$ and to raise it again to the value given in 2.2. When the turning speed $r_2 = 0$ is reached, the time t_2 shall be noted. When the turning speed r_3 given in 2.2 is reached, the helm must be reversed to the same angle δ , so as to complete the turning movement. The time t_3 shall be noted. When the turning speed $r_4 = 0$ is reached, the time t_4 shall be noted and the vessel or convoy returned to its original course by the requisite rudder movements.

- 2.2 The following limit values shall be complied with to reach turning speed r according to the dimensions of the vessels or convoys and the depth of water h :

| Designation | Dimensions of vessels or convoys $L \times B$ | Turning speed to be complied with $r_1 = r_3$ (°/min) | | Limit values for the time t_4 (s) in still water and in deep water | | |
|-------------|--|--|---------------------|---|-----------------|-----------|
| | | $\delta = 20^\circ$ | $\delta = 45^\circ$ | $1.2 \leq h/T \leq 1.4$ | $1.4 < h/T < 2$ | $h/T > 2$ |
| 1 | All self-propelled vessels and single-file convoys $\leq 110 \times 11.45$ m | 20°/min | 28°/min | 150 s | 110 s | 110 s |
| 2 | Single-file convoys up to 193×11.45 m or two-abreast convoys up to 110×22.90 m | 12°/min | 18°/min | 180 s | 130 s | 110 s |
| 3 | Two-abreast convoys $\leq 193 \times 22.90$ | 8°/min | 12°/min | 180 s | 130 s | 110 s |
| 4 | Two-abreast convoys up to 270×22.90 m or three-abreast convoys up to 193×34.35 m | 6°/min | 8°/min | *) | *) | *) |

*) As established by the nautical expert

The times t_1 , t_2 , t_3 and t_4 required to reach turning speeds r_1 , r_2 , r_3 and r_4 shall be recorded in the report contained in annex 2. The t_4 values shall not exceed the limits established in the table.

2.3 Four evasive manoeuvres at least shall be effected, namely:

- to starboard with a rudder angle $\delta = 20^\circ$
- to port with a rudder angle $\delta = 20^\circ$
- to starboard with a rudder angle $\delta = 45^\circ$
- to port with a rudder angle $\delta = 45^\circ$.

If necessary (e.g. in the case of the non reliability of the values measured or of unsatisfactory manoeuvres), the evasive action shall be repeated. The turning speeds listed in 2.2 and the time limits should be complied with. For active rudders or special types of rudder, a position δ of the rudder unit or rudder angle δ other than $\delta = 20^\circ$ and $\delta = 45^\circ$ may be selected, according to the expert's assessment, based on the type of rudder equipment.

2.4 In order to determine the turning speed, a rate-of-turn indicator conforming to the minimum requirements and test conditions for rate-of-turn indicators shall be on board.

2.5 In accordance with article 5.04, the degree of loading during the evasive action test shall be between 70% and 100% of the maximum deadweight. If the test is performed with a smaller load, approval for downstream and upstream navigation shall be restricted to that load limit.

The procedure for evasive action and the terms used are represented in a diagram annexed to this document.

3. Turning capability

The turning capability of vessels and convoys whose length (L) does not exceed 86 m and width (B) does not exceed 22.90 m shall be considered adequate under article 5.10, in conjunction with article 5.02 (1), when during an upstream turning manoeuvre based on an initial speed relative to the water of 13 km/h and observing the keel clearance conditions of paragraph 1.2, the limit values for stopping facing downstream established in Administrative Instruction No. 2 are complied with.

4. Other requirements

4.1 Notwithstanding paragraphs 1 to 3, the following requirements shall be met:

- (a) For manually controlled rudder equipment, a single turn of the wheel shall correspond to a rudder angle of at least 3°;
- (b) For mechanically controlled rudder equipment, when the rudder is at maximum depth, it shall be possible to achieve an average angular velocity of 4°/s over the rudder's entire rotational field.

This requirement shall also be met, with the vessel at full speed, for rudder settings from 35° port to 35° starboard. In addition, it should be ascertained that the rudder holds maximum angle at maximum propelling power. For active rudder equipment or special types of rudder, this provision applies by analogy.

4.2 If any of the additional equipment referred to in article 5.05 has been needed, it shall meet the requirements of chapter 6, and the following particulars shall be entered in item 52 of the ship's certificate: "Flanking rudders*/forward installation of the rudder*/other equipment* is*/are* necessary to comply with the manoeuvrability requirements of chapter 5".

*) Delete as necessary.

5. Recording of data and reports

The measurements, reports and recording of data shall be carried out according to the procedure set out in annex 2.

Annex 1

Diagram of the evasive action manoeuvre

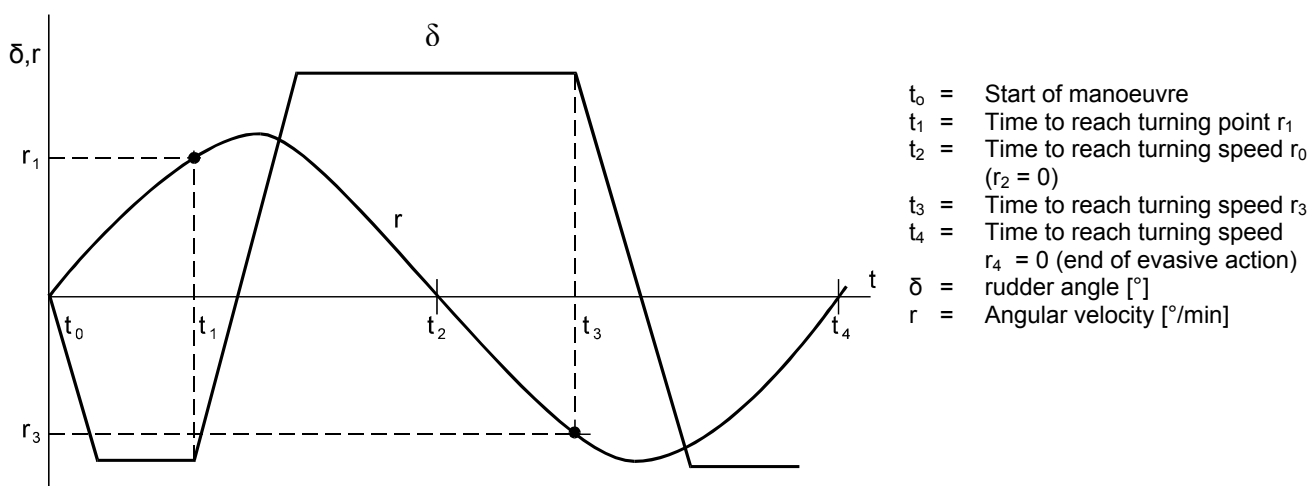

Annex 2

Report on evasive action and turning capabilities

Inspection commission:

Date:

Name:

Name of vessel:

Owner:

Type of vessel Sector:

or convoy: Scale (m):

L x B (m x m): Depth of water (m):

T_{test} (m):Load % of maximum
(during test) [t]: deadweight:

Rate-of-turn indicator

Type:

Type of rudder construction: normal construction/special construction*

Active rudder equipment: yes/no*

Results of evasive action manoeuvres:

| Time required t ₁ to t ₄ for the evasive action | Rudder angle δ or δ^* at which evasive action commences and turning speed to be complied with $r_1 = r_3$ | | | | Comments |
|---|--|---------------------------|---------------------------|---------------------------|----------|
| | $\delta = 20^\circ$ STAR* | $\delta = 20^\circ$ PORT* | $\delta = 45^\circ$ STAR* | $\delta = 45^\circ$ PORT* | |
| | $\delta = \dots$ STAR* | $\delta = \dots$ PORT* | $\delta = \dots$ STAR* | $\delta = \dots$ PORT* | |
| | $r_1 = r_3 = \dots$ /min | | $r_1 = r_3 = \dots$ /min | | |
| t ₁ (s) | | | | | |
| t ₂ (s) | | | | | |
| t ₃ (s) | | | | | |
| t ₄ (s) | | | | | |
| Limit value t ₄ according to 2.2 | Limit value t ₄ = ... (s) | | | | |

Turning capability*

Position at start of turning manoeuvre k.p.

Position at end of turning manoeuvre k.p.

Steering apparatus

Type of operation: manual/motorized*

Rudder movement for each turn of the wheel*: °/s

Angular velocity of the rudder over the whole field*: °/s

Angular velocity of the rudder over the sector * 35° Port to 35° Starboard: °/s

* Delete as necessary.

ADMINISTRATIVE INSTRUCTION NO. 2
IN ACCORDANCE WITH ARTICLE 1.07 OF THE ANNEX II OF THE DIRECTIVE

**Requirements concerning prescribed maximum speed,
stopping capacity and capacity for going astern**

(Articles 5.06, 5.07 and 5.08 in relation to articles 5.02 (1); 5.03 (1); 5.04 and 16.06)

1. Maximum prescribed speed in accordance with article 5.06

The speed relative to the water is adequate within the meaning of article 5.06, paragraph 1, when it reaches at least 13 km/h. During tests, the following conditions must be met as in the case of the stopping test:

- (a) the conditions of keel clearance set out in paragraph 2.1 must be complied with,
- (b) the measurements, entries in test reports and registration of test data must be carried out.

2. Stopping capacity and navigability while going astern prescribed in accordance with articles 5.07 and 5.08

2.1 Vessels and convoys are able to stop facing downstream in good time in accordance with article 5.07, paragraph 1, when this is proved in the course of the test of stopping relative to the bank facing downstream at an initial speed through the water of 13 km/h, with a keel clearance equal to at least 20% of the draught but not less than 0.50 m.

- (a) In running water (current velocity of: 1.5 m/s), stopping relative to the water shall be effected over a distance measured relative to the bank of:

550 m for vessels and convoys of:

- length $L > 110$ m and
- width $B > 11.45$ m

or

480 m for vessels and convoys of:

- length $L \leq 110$ m and
- width $B \leq 11.45$ m.

The stopping manoeuvre is completed on coming to a stop relative to the bank.

- (b) In still water (current velocity of less than 0.2 m/s), stopping relative to the water must be effected over a distance, measured relative to the bank of:

not more than 350 m for vessels and convoys of:

- length $L > 110$ m and
- width $B > 11.45$ m

or

305 m for vessels and convoys of:

- length $L < 110$ m and
- width $B < 11.45$ m.

In still water, a test shall also be performed to establish that a speed of not less than 6.5 km/h can be reached when going astern.

The measurements, inclusion in test reports and recording of the test data referred to in (a) or (b) shall be effected in accordance with the procedure set out in annex 1.

Throughout the test, the vessel or the convoy shall have adequate manoeuvrability.

2.2 Under article 5.04, during the test, vessels shall be loaded as far as possible to 70-100% of their deadweight. The degree of loading shall be evaluated in accordance with annex 2. When the load of the vessel or the convoy is less than 70 % at the time of the test, the permitted displacement in downstream navigation shall be determined on the basis of the actual load, provided that the limit values of paragraph 2.1 are respected.

2.3 If the actual values of the initial speed and current velocity at the time of the test do not meet the condition established in 2.1, the results obtained shall be evaluated according to the procedure described in annex 2.

If the permitted difference in respect of the initial speed of 13 km/h shall be not more than ± 1 km/h, and the current velocity in running water must be between 2.3 and 2.2 m/s, otherwise the tests must be repeated.

2.4. The maximum permitted displacement for vessels and convoys in downstream navigation shall be established on the basis of the tests and entered in the ship's certificate.

Annex 1

MEASUREMENT, REPORT AND RECORDING OF DATA COLLECTED DURING STOPPING MANOEUVRE TESTS

1. Stopping manoeuvre

The vessels and convoys referred to in Chapter V shall perform a test in running water or in still water, in a test sector, to prove that they are capable of stopping facing downstream with the help of their propelling installations without the use of anchors. The stopping manoeuvre shall, in principle, be conducted in accordance with figure 1. It begins when the vessel is travelling at a steady speed - 13 km/h relative to the water, as far as possible be reversing the engines from "ahead" to "astern" (point **(A)** of the order "stop") and is completed when the vessel is stationary relative to the bank (point **(E)** $v = 0$ relative to the bank or point **(D)** = point **(E)** $v = 0$ relative to the water and relative to the bank if the stopping manoeuvre is carried out in still water.

When stopping manoeuvres are carried out in running water, the position and the moment of stopping relative to the water should also be recorded (the boat moves at the speed of the current; point **(D)** $v = 0$ relative to the water).

The data measured shall be entered in a report from as illustrated in the graph of table 1. Before the stopping manoeuvre takes place, the fixed data should be entered at the top of the form.

The average speed of the current (v_{STR}) in the navigable channel shall be determined, if known, on the basis of the reading scale, or by measuring the movement of a floating body, and shall be entered in the report.

In principle, the use of current metres is permitted to determine the speed of the vessel relative to the water during the stopping manoeuvre, if this enables the sequence of movements and measurements described above to be recorded.

2. Recording the data measured and entering them in the report (table 1)

For the stopping manoeuvre, the initial speed relative to the water must first of all be determined. This can be done by measuring the time taken to travel between two markers on land. In running water, the average speed of the current must be taken into consideration.

The stopping manoeuvre is initiated by the order “stop” (A), given on passing a marker on land. Passage of the land marker is recorded at a point perpendicular to the axis of the vessel and must be entered in the report. The passage of all other land markers during the stopping manoeuvre is recorded in the same way and each marker (e.g. kilometre post) and the time it is passed are noted in the report.

The values measured must, if possible, be recorded at intervals of 50 m. In each case, note should be taken of the time when points (B) and (C) - if possible—as well as points (D) and (E) are reached and the position evaluated. The data concerning the number of revolutions need not be recorded in the report, but should be noted to permit more accurate control of the initial speed.

3. Description of the execution of the stopping manoeuvre

The execution of the stopping manoeuvre according to figure 1 shall be presented in the form of a diagram. First of all, the distance-time curve must be plotted using the measurements entered in the rest report and points (A) and (E) marked. It will then be possible to determine the average speed between two measurement points and to plot the speed/time curve.

This is done as follows (see figure 1):

By determining the quotient of the difference of position over the difference in time $\Delta S/\Delta t$, the average speed of the vessel for this period may be calculated.

During the interval between 0 sec. and 10 sec., the distance from 0 m to 50 m is covered.

$$\Delta S/\Delta t = 50 \text{ m}/10 \text{ s} = 5.0 \text{ m/s} = 18.0 \text{ km/h}$$

This value is entered as the average speed for a 5 sec. abscissa. During the second interval, from 10 sec. to 20 sec., a distance of 45 m is covered.

$$\Delta S/\Delta t = 45 \text{ m}/10 \text{ s} = 4.5 \text{ m/s} = 16.2 \text{ km/h}$$

Perpendicular to marker (D), the vessel has stopped relative to the water i.e. current speed is approximately 5 km/h.

Figure 1: Execution of the stopping manoeuvre

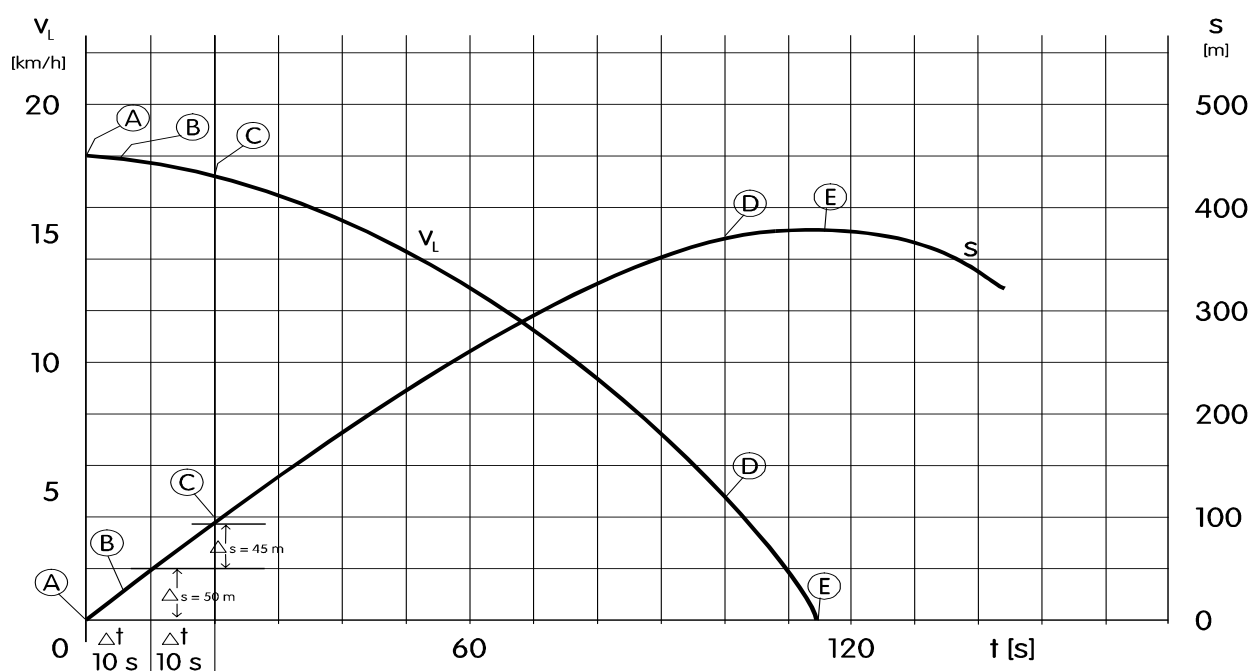
Key to symbols

- (A)** “stop” order
- (B)** propeller stopped
- (C)** propeller in reverse
- (D)** $v = 0$ relative to the water
- (E)** $v = 0$ relative to the bank
- v speed of vessel
- v_L v relative to the bank
- s distance covered relative to the bank
- t time elapsed

Annex 2

EVALUTATION OF THE RESULTS OF THE STOPPING MANOEUVRE

1. Observance of the limit values in accordance with annex 1 must be verified on the basis of the values recorded. When the conditions for the stopping manoeuvre differ substantially from the standard conditions, or when there are doubts as to the observance of the limit values, the results must be evaluated. The following procedure may be applied in calculating stopping manoeuvres.

2. Theoretical stopping distances are determined under the standard conditions (s_{SOLL}) of paragraph 2.1 of the Administrative Instruction and under stopping manoeuvre conditions (s_{IST}) and are compared with the stopping distance measured ($s_{MESSUNG}$). The corrected stopping distance of the stopping manoeuvre under standard conditions (s_{NORM}) is calculated as follows:

2.1
$$s_{NORM} = s_{MESSUNG} \cdot \frac{s_{SOLL}}{s_{IST}} < \text{limit value in accordance with paragraph 2.1(a) or (b) of the Instruction}$$

When the stopping manoeuvre has been effected by the calculation of s_{NORM} with a load of 70 – 100 % of the maximum deadweight in accordance with paragraph 2.2 of the Administrative Instruction, in order to calculate s_{SOLL} and s_{IST} , the displacement of water ($D_{SOLL} = D_{IST}$) corresponding to the load at the time of the test shall be used.

When in determining s_{NORM} according to the 2.1 formula, the limit value in question proves to have been exceeded or not reached, the value of s_{SOLL} should be reduced or increased by the variation of D_{SOLL} so that the limit value is respected ($s_{NORM} = \text{limit value in question}$). The maximum displacement permitted in downstream navigation is to be established accordingly.

3. According to the limit values established in paragraph 2.1 (a) and (b) of the Administrative Instruction, only the stopping distances measured in Phase I (“Full ahead” reversed to “full astern”): S_I and Phase II (End of reversal until vessel stops relative to the water); S_{II} are to be calculated (see figure 1).

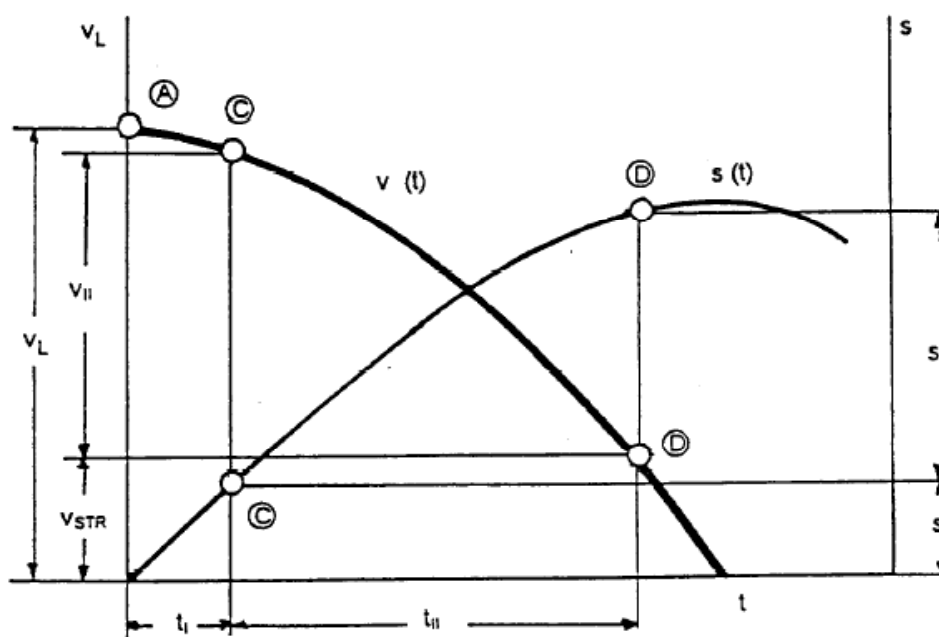

One total stopping distance is then:

$$3.1 \quad S_{ges} = S_I + S_{II}$$

4. The stopping distances alone are to be calculated as follows:

Calculation formulae:

with the following coefficients

$$4.1 \quad S_I = k_1 \cdot v_L \cdot t_I \quad t_I \leq 20 \text{ s}$$

- k_1 according to table 1

$$4.2 \quad S_{II} = k_2 \cdot v_{II}^2 \cdot \frac{D \cdot g}{k_2 \cdot F_{POR} + R_{TmII} \cdot R_G} - \left(k_4 + \frac{v_{STR}}{v_{II}} \right)$$

- k_2, k_3, k_4 according to table 1

$$4.3 \quad R_{TmII} = \left(\frac{R_T}{v^2} \right) \cdot (k_7 \cdot k_6 \cdot (v_L - v_{STR}))^2$$

- k_5, k_7 according to table 1

- R_T/v^2 according to table 3

$$4.4 \quad R_G = i \cdot D \cdot \rho \cdot g \cdot 10^{-6}$$

$$4.5 \quad v_{II} = k_6 \cdot (v_L - v_{STR})$$

- k_6 according to table 1

$$4.6 \quad F_{POR} = f \cdot P_8$$

- f according to table 2

$$4.7 \quad t_{II} = \frac{S_{II}}{v_{II} - \left(k_4 + \frac{v_{STR}}{v_{II}} \right)}$$

- k_4 according to table 1

In formulae 4.1 to 4.7:

| | | |
|------------|---|----------------------|
| v_L | Speed relative to the bank at the start of reversal | (m/s) |
| t_I | Reversal time | (s) |
| v_{II} | Speed relative to the water at the end of reversal | (m/s) |
| D | Displacement of water | (m ³) |
| F_{POR} | Tractive force at the fixed point, in reverse | (kN) |
| P_B | Power of propulsion engine | (kW) |
| R_{TmII} | Average resistance during phase II, to be determined using the diagram for calculating resistance | (kN) |
| R_G | Resistance to gradient | (kN) |
| i | Gradient in m/km (in the absence of data = 0.16) | (m/km) |
| v_{STR} | Average speed of current | (m/s) |
| g | Acceleration of gravity (9.81) | (m/s ²) |
| ρ | Density of water, ρ fresh water = 1,000 | (kg/m ³) |
| T | Maximum deadweight (of vessel or convoy) | (m) |
| h | Depth of water | (m) |
| B | Width | (m) |
| L | Length | (m) |

The coefficients for the formulae 4.1, 4.2, 4.3, 4.4, 4.5, 4.6 and 4.7 can be found in tables below.

Table 1: *k* factors for

- a. SELF-PROPELLED VESSELS and CONVOYS, single file
- b. Two-abreast CONVOYS
- c. Three-abreast CONVOYS

| | (a) | (b) | (c) | Units |
|-------|-------|-------|-------|----------------------------|
| k_1 | 0.95 | 0.95 | 0.95 | - |
| k_2 | 0.115 | 0.120 | 0.125 | $\frac{kg \cdot s^2}{m^4}$ |
| k_3 | 1.20 | 1.15 | 1.10 | - |
| k_4 | 0.48 | 0.48 | 0.48 | - |
| k_6 | 0.90 | 0.85 | 0.80 | - |
| k_7 | 0.58 | 0.55 | 0.52 | - |

Table 2: Coefficient *f* for ratio between the tractive force at the fixed point in reverse and the power of the propulsion engines

| Propulsion system | <i>f</i> | Units |
|--|----------|-------|
| Modern nozzles with rounded rear edge | 0.118 | kN/kW |
| Old nozzles with sharp rear edge | 0.112 | kN/kW |
| Propellers with no nozzle | 0.096 | kN/kW |
| Steering propellers with nozzles (generally sharp rear edge) | 0.157 | kN/kW |
| Steering propellers with no nozzles | 0.113 | kN/kW |

Table 3: Diagram concerning the calculation of resistance

To determine the value of R_T/v^2 in relation to $D^{1/3} [B + 2T]$:

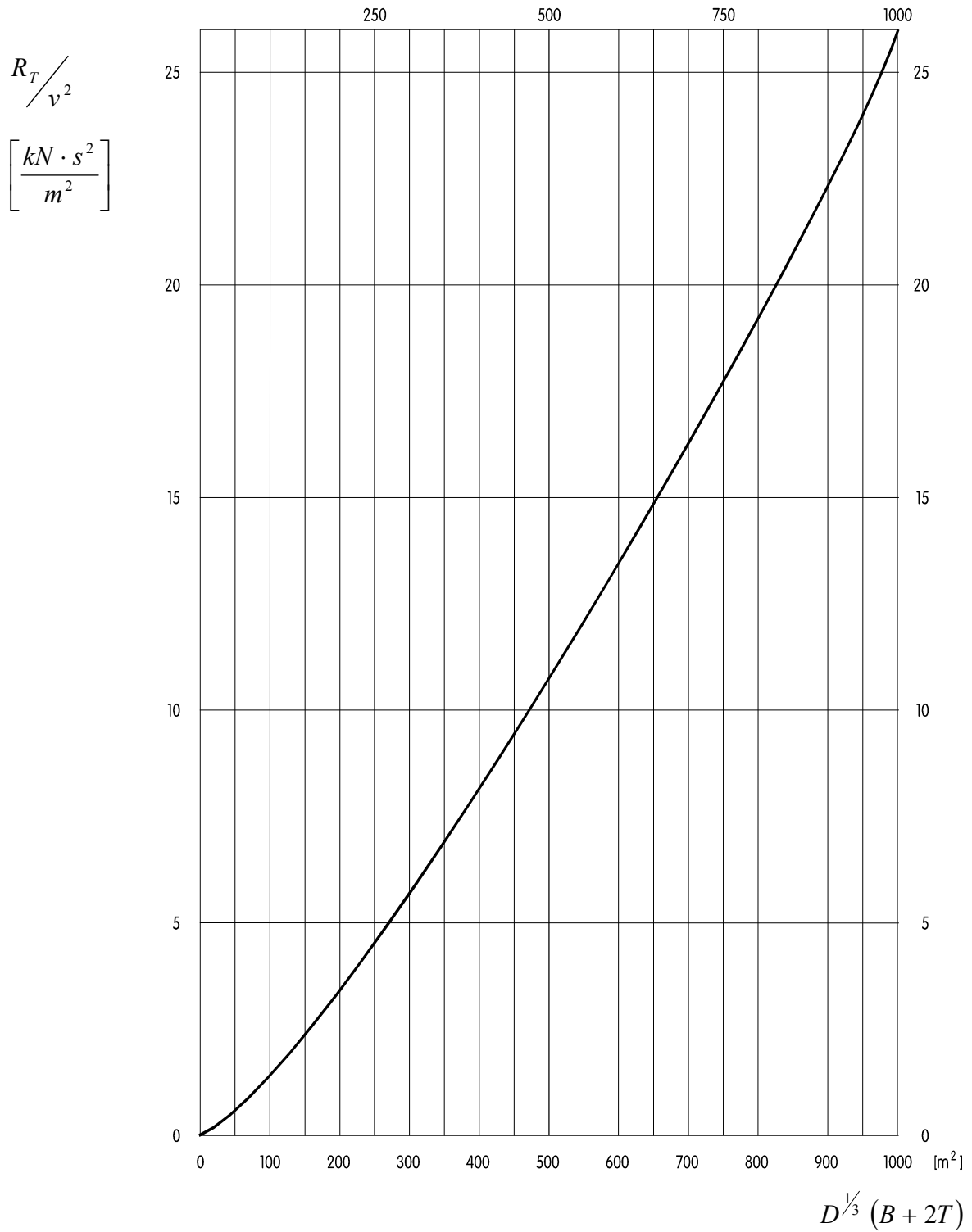

**EXAMPLES OF THE APPLICATION OF ANNEX 2
(for the use of the results of the stopping tests)**

EXAMPLE I

1. Data relating to the convoy and its components

Formation: ordinary self-propelled vessel with a (Europa IIa) pushed barge coupled abreast

| | L [m] | B [m] | T_{max} [m] | Tgf_{max}^* [t] | D_{max} [m ³] | P_B [kW] |
|------------------------------|---------|---------|---------------|-------------------|-----------------------------|------------|
| Self-propelled vessel | 110 | 11.4 | 3.5 | 2900 | 3731 | 1500 |
| Pushed barge | 76.5 | 11.4 | 3.7 | 2600 | 2743 | - |
| Convoy | 110 | 22.8 | 3.7 | 5500 | 6474 | 1500 |

Propulsion system of the self-propelled vessel: modern nozzles with rounded rear edge

* Tgf = deadweight.

2. Values measured during the stopping manoeuvre

| | | | | |
|--|-----------------|---|---------------------|-----------------|
| Speed of current: | $V_{STR_{IST}}$ | = | 1.4 m/s | ≈ 5.1 km/h |
| Speed of vessel: (relative to the water) | $V_{S_{IST}}$ | = | 3.5 m/s | ≈ 12.5 km/h |
| Speed of vessel: (relative to the bank): | $V_{L_{IST}}$ | = | 4.9 m/s | ≈ 17.6 km/h |
| Reversal time (measured) (point (A) to (C)): | t_i | = | 16 s | |
| Stopping distance relative to water: (point (A) to (D)): | | = | $s_{MESSUNG}$ | = 340 m |
| Degree of loading (possibly estimated): | D_{IST} | = | 5179 m ³ | ≈ 0.8 D_{max} |
| Actual draught of convoy: | T_{IST} | = | 2.96 m | ≈ 0.8 T_{max} |

3. Limit value according to 2.1 (a) or (b) to be compared with s_{NORM}

Since $B > 11.45$ m and since the convoy is in running water, the following is applicable for this convoy under 2.1 (a):

$$s_{NORM} \leq 550 \text{ m}$$

4. Determination of corrected stopping distance compared to standard conditions

- Measurement according to annex 1 (see 2)

$$s_{MESSUNG} = 340 \text{ m}$$

- Calculation to be made:

s_{IST} sum of

$s_{L_{IST}}$ (according to formula 4.1 of annex 2 with $v_{L_{IST}}$)

- and $s_{II_{IST}}$ (according to formulae 4.2, 4.3, 4.4, 4.5 and 4.6 of annex 2 with real speeds $v_{II_{IST}}$, $v_{STR_{IST}}$, D_{IST})

s_{SOLL} sum of

$s_{I_{SOLL}}$ (according to formula 4.1 or annex 2 with $v_{L_{SOLL}}$)

- and $s_{II_{SOLL}}$ (according to formulae 4.2 to 4.6 of annex 2 with the standard speeds according to 2.1 of the Administrative Instruction and given that the degree of loading is greater than 70% (= 80%): $D_{SOLL} = D_{IST}$ and $T_{SOLL} = T_{IST}$)

- to be checked:

$$s_{NORM} = s_{MESSUNG} \cdot \frac{s_{SOLL}}{s_{IST}} \leq 555 \text{ m}$$

4.1 Initial data for the calculation

Table 1

| | |
|--|--------------|
| for $s_{I_{IST}}$ and $s_{I_{SOLL}}$ | $k_1 = 0.95$ |
| for $s_{II_{IST}}$ and $s_{II_{SOLL}}$ | $k_2 = 0.12$ |
| | $k_3 = 1.15$ |
| | $k_4 = 0.48$ |
| | $k_6 = 0.85$ |
| | $k_7 = 0.55$ |

Table 2 (for modern nozzles with rounded rear edge)

$$f = C.118$$

4.2 Calculation of s_{IST}

- (a) $s_{I_{IST}}$ with the values measured during the stopping manoeuvre (formula 4.1)

$$s_{I_{IST}} = k_1 \cdot v_{L_{IST}} \cdot t_{I_{IST}}$$

$$s_{I_{IST}} = 0.95 \cdot 4.9 \cdot 16 = \underline{74.5 \text{ m}}$$

- (b) Formula for $s_{II_{IST}}$

$$s_{II_{IST}} = k_2 \cdot v_{II_{IST}}^2 \cdot \frac{D_{IST} \cdot g}{k_3 \cdot F_{POR} + R_{TmII_{IST}} R_G} \cdot \left(k_4 + \frac{v_{STR_{IST}}}{v_{II_{IST}}} \right)$$

- (c) Calculation of
- $R_{TmII_{IST}}$
- according to table 3 and formula 4.3 of annex 2

$$D_{IST}^{1/3} = 5179^{1/3} = 17.3 \text{ [m]}$$

$$D_{IST}^{1/3} = (B + 2 \cdot T_{IST}) = 17.3 \cdot (22.8 + 5.92) = 495.8 \text{ [m}^2\text{]}$$

$$\text{according to table 3} \quad \frac{R_T}{v^2} = 10.8 \left[\frac{\text{kN} \cdot \text{s}^2}{\text{m}^2} \right]$$

$$v_{L_{IST}} - v_{STR_{IST}} = 4.9 - 1.4 = 3.5 \text{ m/s}$$

$$R_{TmII_{IST}} = \frac{R_T}{v^2} \cdot (k_7 \cdot k_6 \cdot (v_{L_{IST}} - v_{STR_{IST}}))^2 = 10.8 \cdot (0.55 \cdot 0.85 \cdot 3.5)^2 = \underline{28.8} \text{ [kN]}$$

- (d) Calculation of resistance to gradient
- R_G
- according to formula 4.4

$$R_G = 10^{-6} \cdot (0.16 \cdot D_{IST} \cdot \rho \cdot g) = 10^{-6} \cdot (0.16 \cdot 5179 \cdot 1000 \cdot 9.81) = \underline{8.13} \text{ [kN]}$$

- (e) Calculation of
- $dev_{II_{IST}}$
- according to formula 4.5

$$v_{II_{IST}} = k_6 \cdot (v_{L_{IST}} - v_{STR_{IST}}) = (0.85 \cdot 3.5) = 2.97 \text{ [m/s]}$$

$$v_{II_{IST}}^2 = 8.85 \text{ [m/s]}^2$$

- (f) Calculation of
- F_{POR}
- according to formula 4.6 and table 2

$$F_{POR} = 0.118 \cdot 1500 = \underline{177} \text{ [kN]}$$

- (g) Calculation of
- $s_{II_{IST}}$
- using formula (b) and the result of (c), (d), (e) and (f)

$$s_{II_{IST}} = \frac{0.12 \cdot 8.85 \cdot 9.81 \cdot \left(0.48 + \frac{1.4}{2.97}\right)}{1.15 \cdot 177 + 28.8 - 8.13} \cdot 5179$$

$$s_{II_{IST}} = \underline{228.9 \text{ m}}$$

- (h) Calculation of total distance according to formula 3.1

$$s_{IST} = 74.51 + 228.9 = \underline{303.4 \text{ m}}$$

Notes: Given that the term $(R_{TmII} - R_G)$ as a function of D with 20.67 kN is obviously relatively small compared with $k_3 \cdot F_{POR}$ with 203.55 kN, for simplification purposes, s_{II} can be taken as proportional to D , i.e. $s_{II} = \text{Constant} \cdot D$.

4.3 Calculation of s_{SOLL}

Initial values

$$v_{STR_{SOLL}} = 1.5 \text{ m/s} = 5.4 \text{ km/h}$$

$$D_{SOLL} = D_{IST} = 5179 \text{ m}^3$$

$$v_{S_{SOLL}} = 3.6 \text{ m/s} = 13 \text{ km/h}$$

$$T_{SOLL} = T_{IST} = 2.96 \text{ m}$$

$$v_{L_{SOLL}} = 5.1 \text{ m/s} = 18.4 \text{ km/h}$$

$$(a) \quad s_{I_{SOLL}} = k_1 \cdot v_{L_{SOLL}} \cdot t_I$$

$$s_{I_{SOLL}} = 0.95 \cdot 5.1 \cdot 16 = \underline{77.50 \text{ m}}$$

$$(b) \quad s_{II_{SOLL}} = k_2 \cdot v_{II_{SOLL}}^2 \cdot \frac{D_{SOLL} \cdot g}{k_3 \cdot F_{POR} \cdot R_{TmII_{SOLL}} \cdot R_G} \cdot \left(k_4 + \frac{v_{STR_{SOLL}}}{v_{II_{SOLL}}} \right)$$

(c) calculation of $R_{TmII_{SOLL}}$

$$\frac{R_T}{v^2} = 10.8 \left[\frac{kN \cdot s^2}{m^2} \right] \text{ as under 4.2, since } B, D \text{ and } T \text{ are unchanged.}$$

$$v_{L_{SOLL}} - v_{STR_{SOLL}} = 3.6 \text{ [m/s]}$$

$$R_{TmII_{SOLL}} = \frac{R_T}{v^2} \cdot (k_7 \cdot k_6 \cdot (v_{L_{SOLL}} - v_{STR_{SOLL}}))^2 = 10.8 \cdot (0.55 \cdot 0.85 \cdot 3.6)^2 = \underline{30.99 \text{ [kN]}}$$

(d) Resistance to the gradient R_G as in 4.2

(e) Calculation of $v_{II_{SOLL}}$

$$v_{II_{SOLL}} = k_6 \cdot (v_{L_{SOLL}} - v_{STR_{SOLL}}) = 0.85 \cdot 3.6 = \underline{3.06 \text{ [m/s]}}, \quad v_{II_{SOLL}}^2 = 9.36 \text{ [m/s]}^2$$

(f) F_{POR} as in 4.2.

(g) Calculation of $s_{II_{SOLL}}$ using formula (b) and the result from (c) to (f)

$$s_{II_{SOLL}} = \frac{0.12 \cdot 9.36 \cdot 9.81 \cdot \left(0.48 + \frac{1.5}{3.06} \right)}{1.15 \cdot 177 + 30.99 - 8.13} \cdot 5179$$

$$= \underbrace{0.0472}_{\text{Constant}_{SOLL}} \cdot 5179 = \underline{244.5 \text{ m}}$$

(h) Calculation of total distance

$$s_{SOLL} = s_{I_{SOLL}} + s_{II_{SOLL}} = 77.5 + 244.5 = \underline{322 \text{ m}}$$

4.4 Verification that the permissible stopping distance under standard conditions s_{NORM} is respected

according to formula 2.1 of annex 2

$$s_{NORM} = s_{MESSLUNG} \cdot \frac{s_{SOLL}}{s_{IST}} = 340 \cdot \frac{322}{303.4} = \underline{360.8 \text{ m} < 550 \text{ m}}$$

Conclusion:

The permissible limit value is far from being reached, i.e.:

- admission to downstream navigation is possible without problems given the degree of loading submitted ($0.8 \cdot D_{\max}$),
- a higher degree of loading is possible and may be calculated according to 5 below.

5. Possible increase of D_{IST} in downstream navigation

$$(s_{NORM})_{Limit} = s_{MESSUNG} \cdot \frac{(s_{SOLL})_{Limit}}{s_{IST}} = 550 \text{ m}$$

$$(s_{SOLL})_{Limit} = 550 \cdot \frac{s_{IST}}{s_{MESSUNG}} = 550 \cdot \frac{303.4}{340} = 490.8 \text{ m}$$

Where $s_{II_{SOLL}} = \text{Constant}_{SOLL} \cdot D$ according to the notes under 4.2

$$(s_{SOLL})_{Limit} = (s_{I_{SOLL}} + s_{II_{SOLL}})_{Limit} = s_{I_{SOLL}} + 0.0472 \cdot (D_{SOLL})_{Limit}$$

is obtained, hence

$$(D_{SOLL})_{Limit} = \frac{(s_{I_{SOLL}})_{Limit} - s_{I_{SOLL}}}{0.0472} = \frac{490.8 - 77.5}{0.0472} = \underline{8756 \text{ m}^3}$$

As a result:

Since $(D_{SOLL})_{Limit} > D_{\max}$ ($8756 > 6474$) this formation (see 1) may be permitted in downstream navigation with a full load.

EXAMPLE II1. Data concerning the vessels and the convoy

Formation: self-propelled vessel-pusher with
2 leading pushed barges and
1 pushed barge coupled abreast

| | L [m] | B [m] | T_{\max} [m] | Tgf^*_{\max} [t] | D_{\max} [m ³] | P_B [kW] |
|------------------------------|---------|---------|----------------|--------------------|------------------------------|------------|
| Self-propelled vessel | 110 | 11.4 | 3.5 | 2900 | 3731 | 1500 |
| Each pushed barge | 76.5 | 11.4 | 3.7 | 2600 | 2743 | - |
| Convoy | 186.5 | 22.8 | 3.7 | 10700 | 11960 | 1500 |

Propulsion system of the self-propelled vessel: modern nozzles with rounded rear edge.

* Tgf = deadweight

2. Values measured during the stopping manoeuvre

| | |
|---|--|
| Speed of current | $v_{STR_{IST}} = 1.4 \text{ m/s} \approx 5.1 \text{ km/h}$ |
| Speed of vessel (relative to the water) | $v_{s_{IST}} = 3.5 \text{ m/s} \approx 12.5 \text{ km/h}$ |
| Speed of vessel (relative to the bank) | $v_{L_{IST}} = 4.9 \text{ m/s} \approx 17.6 \text{ km/h}$ |
| Duration of reversal measured (point (A) to (C)) | $t_I = 16 \text{ sec}$ |
| Stopping distance relative to the water: (point (A) to (D)) | $s_{MESSUNG} = 580 \text{ m}$ |
| Load situation (possibly estimated): | $D_{IST} = 9568 \text{ m}^3 \approx 0.8 D_{\max}$ |
| Actual draught of convoy: | $T_{IST} = 2.96 \approx 0.8 T_{\max}$ |

3. Limit value according to paragraph 2.1 (a) or (b) of the Administrative Instruction to be compared with s_{NORM}

Since $B > 11.45$ and the convoy is in running water, the following applies for this convoy under 2.1 (a):

$$s_{NORM} \leq 550 \text{ m}$$

4. Determination of the corrected stopping distance compared with standard conditions

- Measurement: $s_{MESSUNG} = 340 \text{ m}$

- calculations to be made:

s_{IST} sum of

$s_{I_{IST}}$ (according to formula 4.1 of annex 2 with $V_{L_{IST}}$)

and $s_{II_{IST}}$ (according to formulae 4.2, 4.3, 4.4, 4.5 and 4.6 of annex 2 with real speeds v_{IST} (see under 2 above) and D_{IST})

$s_{SOLL} : \text{sum } s_{I_{SOLL}} + s_{II_{SOLL}}$ (according to formulae 4.1 to 4.6 of annex 2 with standard speeds and in conformity of annex 2, because the degree of loading $> 70\%$, where $D_{SOLL} = D_{IST}$ and $T_{SOLL} = T_{IST}$)

- to be verified:

$$s_{NORM} = s_{MESSUNG} \cdot \frac{s_{SOLL}}{s_{IST}} \leq 550 \text{ m, otherwise}$$

- calculate:

$$s^*_{NORM} = 550 \text{ m by reduction of } D_{IST} \text{ to } D^*$$

4.1 Coefficients for the calculation of annex 2 in Table 1

$$\text{for } s_{I_{IST}} \text{ and } s_{I_{SOLL}} \quad k_1 = 0.95$$

$$\text{for } s_{I_{IST}} \text{ and } s_{I_{SOLL}} \quad k_2 = 0.12$$

$$k_3 = 1.15$$

$$k_4 = 0.48$$

$$k_5 = 0.85$$

$$k_7 = 0.55$$

From Table 2 (for modern nozzles with rounded rear edge)

$$f = 0.118$$

4.2 Calculation of $s_{I_{IST}}$

(a) $s_{I_{IST}}$ with the values measured during the stopping tests (formula 4.1):

$$s_{I_{IST}} = k_1 \cdot v_{L_{IST}} \cdot t_{I_{IST}}$$

$$s_{I_{IST}} = 0.95 \cdot 4.8 \cdot 16 = \underline{73 \text{ m}}$$

(b) formula for $s_{II_{IST}}$

$$s_{II_{IST}} = k_2 \cdot v_{II_{IST}}^2 \cdot \frac{D_{IST} \cdot g}{k_2 \cdot F_{POR} + R_{TmII_{IST}} - R_G} \cdot \left(k_4 + \frac{v_{STR_{IST}}}{v_{II_{IST}}} \right)$$

(c) Calculation of $R_{TmII_{IST}}$ according to table 3 and formula 4.3 of annex 2

$$D_{IST}^{1/3} = 9568^{1/3} = 21.2 \text{ [m]}$$

$$D_{IST}^{1/3} \cdot (B + 2 \cdot T_{IST}) = 21.2 \cdot (22.8 - 5.92) = 609 \text{ [m}^2\text{]}$$

$$\text{of table 3 } \frac{R_T}{v^2} = 14.0 \frac{\text{kN} \cdot \text{s}^2}{\text{m}^2}$$

$$v_{L_{IST}} - v_{STR_{IST}} = 4.8 - 1.4 = 3.4 \text{ m/s}$$

$$R_{TmII_{IST}} = \frac{R_T}{v^2} \cdot (k_7 \cdot k_6 \cdot (v_{L_{IST}} \cdot v_{STR_{IST}}))^2 = 14.0 \cdot (0.55 \cdot 0.85 \cdot 3.4)^2 = \underline{35.4 \text{ [kN]}}$$

(d) Calculation of resistance to the gradient R_G according to formula 4.4 of annex 2.

$$R_G = 10^{-6} \cdot (0.16 \cdot D_{IST} \cdot \rho \cdot g) = 10^{-6} \cdot (0.16 \cdot 9568 \cdot 1000 \cdot 9.81) = \underline{15.02 \text{ [kN]}}$$

(e) Calculation of $v_{II_{IST}}$ according to formula 4.5 of annex 2

$$v_{II_{IST}} = k_6 \cdot (v_{L_{IST}} \cdot v_{STR_{IST}}) = 2.89 \text{ [m/s]}$$

$$v_{II_{IST}} = 8.35 \text{ [m/s]}^2$$

- (f) Calculation of
- F_{POR}
- according to formula 4.6 and table 2

$$F_{POR} = 0.118 \cdot 1500 = \underline{177} \quad [kN]$$

- (g) Calculation of
- $s_{II_{IST}}$
- using formula (b) and the result of (c), (d), (e) and (f)

$$s_{II_{IST}} = \frac{0.12 \cdot 8.35 \cdot 9.81 \left(0.48 + \frac{1.4}{2.89} \right)}{1.15 \cdot 177 + 35.4 - 15.02} \cdot 9568$$

$$(s_{II_{IST}} = 402 [m])$$

- (h) Calculation of the total distance according to formula 3.1

$$s_{IST} = 73 + 402 = \overline{475} \text{ m}$$

4.3 Calculation of s_{SOLL}

Starting values:

$$v_{STR_{SOLL}} = 1.5 \text{ m/s} \approx 5.4 \text{ km/h}$$

$$D_{SOLL} = D_{IST} = 9568 \text{ m}^3$$

$$v_{S_{SOLL}} = 3.6 \text{ m/s} \approx 13 \text{ km/h}$$

$$T_{SOLL} = T_{IST} = 2.96 \text{ m}$$

$$v_{L_{SOLL}} = 5.1 \text{ m/s} \approx 18.4 \text{ km/h}$$

$$(a) \quad s_{I_{SOLL}} = k_1 \cdot v_{L_{SOLL}} \cdot t_1$$

$$s_{I_{SOLL}} = 0.95 \cdot 5.1 \cdot 16 = \underline{77.50} \text{ m}$$

$$(b) \quad s_{II_{SOLL}} = k_2 \cdot v_{II_{SOLL}}^2 \cdot \frac{D_{SOLL} \cdot g}{k_2 \cdot F_{POR} + R_{TmII_{SOLL}} \cdot R_G} \cdot \left(k_4 + \frac{v_{STR_{SOLL}}}{v_{II_{SOLL}}} \right)$$

- (c) Calculation of
- $R_{TmII_{SOLL}}$

$$\frac{R_T}{v^2} = 14.0 \left[\frac{kN \cdot s^2}{m^2} \right] \text{ as under 4.2 since B, D and T and unchanged}$$

$$v_{L_{SOLL}} \cdot v_{STR_{SOLL}} = 3.6 \quad [m/s]$$

$$R_{TmII_{SOLL}} = 14.0 \cdot (0.55 \cdot 0.85 \cdot 3.6)^2 = \underline{39.6} \quad [kN]$$

- (d) Resistance to the gradient
- R_G
- as under 4.2

- (e) Calculation of
- $v_{II_{SOLL}}$

$$v_{II_{SOLL}} = 0.85 \cdot 3.6 = \underline{3.06} \quad [m/s], \quad v_{II_{SOLL}}^2 = 9.36 \quad [m/s]^2$$

(f) F_{POR} as under 4.2

(g) Calculation of $s_{II_{SOLL}}$ using formula (b) and the result of (c) to (f)

$$s_{II_{SOLL}} = \frac{0.12 \cdot 9.36 \cdot 9.81 \cdot \left(0.48 + \frac{1.5}{3.06}\right)}{1.15 \cdot 177 + 39.6 - 15.02} \cdot 9568$$

$$s_{II_{SOLL}} = \underbrace{0.04684}_{\text{Constant}_{SOLL}} \cdot 9568 = \underline{448 \text{ m}}$$

(h) Calculation to the total distance

$$s_{SOLL} = s_{I_{SOLL}} + s_{II_{SOLL}} = 77.5 + 448 = \underline{525.5 \text{ m}}$$

4.4 Verification of observance of the permissible stopping distance under standard conditions s_{NORM}

according to formula 2.1 of annex 2

$$s_{NORM} = s_{MESSUNG} \cdot \frac{s_{SOLL}}{s_{IST}} = 580 \cdot \frac{525.5}{475} = \underline{641 \text{ m} > 550 \text{ m}}$$

Conclusion: The limit value has clearly been exceeded; admission to downstream navigation is possible only with a load restriction. This restricted load may be determined in conformity with S below.

5. D* permissible in downstream navigation according to formula 2.1 of annex 2

$$s_{NORM} = s_{MESSUNG} \cdot \frac{s_{SOLL}^*}{s_{IST}} = 550 \text{ m}$$

Therefore:

$$s_{SOLL}^* = 550 \cdot \frac{s_{IST}}{s_{MESSUNG}} = s_{I_{SOLL}} + s_{II_{SOLL}}^*$$

$$s_{SOLL}^* = \text{Constant}_{SOLL} \cdot D^* = 0.04684 \cdot D^*$$

$$D^* = \frac{550 \cdot \frac{475}{580} - 77.5}{0.04684} = 7950 \text{ [m]}$$

Consequence: Since in downstream navigation in the permissible displacement D^* is only 7950 m³, the permissible deadweight (zul. Tgf) in this formation is: (by approximation)

$$\frac{\text{zul.}Tgf}{\text{max.}Tgf} = \frac{D^*}{D_{\text{max}}} = \frac{7950}{11960} = 0.66$$

Permissible deadweight (see 1)

$$0.66 \cdot 10700 = 7112 \text{ t}$$

Addendum 4-2**RULES FOR THE CLASSIFICATION AND CONSTRUCTION OF INLAND
NAVIGATION VESSELS OF THE RUSSIAN RIVER REGISTER****15. MANOEUVRABILITY****15.1 APPLICABILITY**

15.1.1 This section sets out manoeuvrability requirements for displacement vessels, which apply to:

- .1 Self-propelled cargo vessels that are 40 metres long or more;
- .2 Displacement passenger vessels, vessels intended to carry no more than 12 passengers and special-purpose vessels that are 20 metres long or more.

15.1.2 The requirements in this section do not apply to pushed convoys, vessels in formation, catamarans or vessels with water-jet or cycloidal propellers or paddle wheels.

15.2 DEFINITIONS AND EXPLANATIONS

15.2.1 The terms used in this section should be understood as follows:

- .1 Propulsion and steering system - the propeller and its steering devices (rudders and/or nozzles);
- .2 Vessel propulsion and steering system - all the propulsion and steering systems that are present on the vessel and ensure its longitudinal movement and manoeuvrability;
- .3 Turning capacity - the vessel's ability to turn within a fairly small radius of curvature;
- .4 Directional stability - the vessel's ability to maintain the chosen straight course in deep still water;
- .5 Manoeuvrability under wind conditions - the vessel's ability to:
Maintain any chosen straight course while all propellers are rotating at rated speed and the wind velocity in the navigational zone does not exceed that indicated in 15.9.2;
Turn on the spot in the chosen direction under wind conditions by simultaneously operating the main controls and the bow steering device;
- .6 Manoeuvrability with propellers not in operation - the vessel's ability to mechanically maintain a straight course under its own momentum, to turn in the chosen direction and to invert the direction of the turn;
- .7 Emergency stopping - quickly changing the operating mode of all the propellers from full speed ahead to full speed astern in deep still water, when loaded as indicated in 15.3.2.

**15.3 GENERAL INSTRUCTIONS FOR SETTING MANOEUVRABILITY
STANDARDS**

15.3.1 A vessel is considered to meet the manoeuvrability requirements set out in this section if, when loaded in accordance with 15.3.2, it satisfies the following criteria:

- .1 Turning capacity (see 15.5);
- .2 Directional stability (see 15.6);
- .3 Manoeuvrability with propellers not in operation (see 15.7);
- .4 Emergency stopping (see 15.8);
- .5 Manoeuvrability under wind conditions (see 15.9).

15.3.2 The manoeuvrability test shall be conducted when the vessel is fully loaded, with an even-keel trim, and fully stocked and refuelled.

Manoeuvrability tests for cargo vessels under wind conditions in accordance with 15.9.2.1 shall be conducted only for vessels in ballast, without cargo, and with 10% of stock and fuel.

Manoeuvrability tests for passenger vessels under wind conditions in accordance with 15.9.2.1 shall be conducted only for vessels without cargo or passengers, and with 10% of stock and fuel.

15.3.3 The vessel manoeuvrability criteria set out in this section apply to vessels with the following types of propulsion and steering systems:

- .1 Screw propellers in steering nozzles;
- .2 Screw propellers in steering nozzles with a centre rudder;
- .3 Rudders behind uncovered screw propellers;
- .4 Rudders behind nozzle propellers.

Manoeuvrability criteria values for vessels with the propulsion and steering systems listed are calculated in accordance with the instructions set out in the “Manual for calculating manoeuvrability and conducting full-scale manoeuvrability tests on inland and combined navigation vessels” (hereinafter referred to as the Manual).

15.3.4 Other well-founded methods can be used to determine manoeuvrability criteria for vessels with the propulsion and steering system types indicated in 15.3.3; the calculation performed in accordance with the Manual shall be submitted to the River Register at the same time.

15.3.5 Methods of determining manoeuvrability criteria for vessels with propulsion and steering system types not indicated in 15.3.3 shall be the subject of special consideration by the River Register.

15.3.6 Criteria for assessing a vessel’s turning capacity, directional stability and manoeuvrability with propellers not in operation can also be determined by:

- .1 Testing an autonomous self-propelled vessel model which is geometrically similar to the vessel;
- .2 Conducting full-scale tests in accordance with the Manual.

In these cases, criteria values do not have to be calculated.

15.4 TABLE OF MANOEUVRABILITY CHARACTERISTICS

15.4.1 To facilitate speedy reference, a table of each vessel's manoeuvrability characteristics shall be posted in a visible place in the wheelhouse.

15.4.2 The table shall be drawn up by the organization responsible for the design of the vessel, and the results of the calculations shall be supplemented or corrected on the basis of data from full-scale tests and tests with self-propelled models.

15.4.3 The form of the table is given in the Manual.

15.5 TURNING CAPACITY

15.5.1 In these Rules, the criterion for measuring turning capacity is the minimum relative mean steady-turning diameter $(D_t/L)_{\min}$, measured from the centre of gravity, that is, the ratio between the diameter D_t of the smallest possible turn which the vessel can make in deep still water and the length L of the vessel at the design waterline DWL , where the speed of rotation of all the propeller screws is the same prior to the commencement of the manoeuvre and is not subsequently regulated.

15.5.2 The vessel's turning capacity is considered to satisfy the requirements set out in the Rules if the relative steady-turning diameter satisfies the condition

$$(D_t/L)_{\min} \leq 2. \quad (15.5.2)$$

15.6 DIRECTIONAL STABILITY

15.6.1 In these Rules, the criterion for measuring directional stability is the minimum relative mean steady-turning diameter, measured from the centre of gravity, which the vessel makes in deep still water with the rudder angle at zero and all propeller screws rotating at the same speed.

15.6.2 The vessel's directional stability is considered to satisfy the requirements set out in the Rules if the steady-turning diameter is 10 or more times the vessel's length, and also if the vessel continues to move on a straight course without turning, with the rudder angle at zero.

15.7 MANOEUVRABILITY WITH PROPELLERS NOT IN OPERATION

15.7.1 The criterion for measuring manoeuvrability with propellers not in operation is the vessel's capacity to come out of a steady turn, made with the rudder at a 20° angle, after the main propellers have stopped, without using the steering device.

15.7.2 The vessel is considered to satisfy the requirements set out in the Rules if it can be taken out of a steady turn, made with the rudder at a 20° angle, after the main propellers have stopped, by operating the main controls, without using the steering device.

15.8 EMERGENCY STOPPING CAPACITY

15.8.1 The criterion for measuring emergency stopping capacity is the vessel's stopping course S_{AT} - the distance, m, which the vessel travels relative to the water from the moment when the order to make an emergency stop is given to the moment when the vessel has come to a complete stop relative to the water.

15.8.2 The vessel is considered to satisfy the requirements set out in this section if the stopping course S_{AT} , m, satisfies the condition

$$S_{AT} = 30.7\sqrt[3]{V} + 1.28L, \quad (15.8.2)$$

Where V is the displacement of the vessel, m^3 ;
 L is the length of the vessel, m.

15.9 MANOEUVRABILITY UNDER WIND CONDITIONS

15.9.1 The criteria for measuring manoeuvrability under wind conditions are:

- .1 Wind velocity in navigational zone, m/s, which allows the vessel to move along any chosen straight course with all propellers rotating at the rated speed;
- .2 The specific thrust of the steering device, kN/m^2 , required for the vessel to turn on the spot using the main controls and the steering device.

The specific thrust of the steering device of a cargo vessel is the ratio $T_E/(L \cdot T)$ between the thrust of the steering device T_E , kN, and the product of the length of the vessel at the *DWL* L and the full-load draught T . The specific thrust of the steering device of a passenger vessel is the ratio T_E/S between the thrust of the steering device T_E , kN, and the sail area S , m^2 .

15.9.2 The vessel's manoeuvrability under wind conditions is considered to satisfy the requirements set out in 15.9.1.1 if the wind velocity in the navigational zone which still allows the vessel to move on any chosen straight course with all the propellers rotating at rated speed is:

For "M" and "O" class vessels - no less than 19 m/s;
 For "P" and "J" class vessels - no less than 14 m/s.^{24/}

15.9.3 The requirement set out in 15.9.1.2 shall be met by installing a bow steering device on the vessel with a specific thrust of no less than the following:

For cargo vessels:

$$T_E(L \cdot T) = 0.03; \quad (15.9.3-1)$$

For passenger vessels with $SL \geq 20,000 m^3$

$$T_E/S = 0.04. \quad (15.9.4-2)$$

15.10 FULL-SCALE TESTS

15.10.1 Full-scale tests designed to determine whether the vessel's manoeuvrability is in compliance with the requirements set out in the Rules, as well as additions and corrections to the table of the vessel's manoeuvrability characteristics, must be effected together with acceptance tests:

- .1 On the prototypes of series-built vessels;
- .2 On individually built vessels;
- .3 On vessels that have been repaired, re-equipped or modernized, if this can alter their manoeuvrability.

^{24/} Chapter 1 of these Recommendations provides that in the Russian Federation, navigational zones 1, 2 and 3 correspond to zones O, P and JI, respectively. Zone M covers waters where wave height can reach 3m.

15.10.2 Full-scale tests must be carried out in accordance with 15.3.2. Deviations with regard to draught must not exceed 10%.

15.10.3 Full-scale manoeuvrability tests on location shall be conducted in deep still water (the depth of the water in the test area must be no less than three times the draught of the vessel), with waves no greater than force 1-2^{25/} and wind velocity no greater than 3-4 m/s.

15.10.4 Full-scale manoeuvrability tests on location shall be conducted using the programme drawn up on the basis of the instructions set out in the Manual and in the Technical Regulations for Supervising over the Construction of Vessel and Manufacturing of Materials and Articles (PTNP).

^{25/} According to the scale of the Central Hydrometeorological Department of the Russian Federation.

Addendum 4-3

**RECOMMENDATIONS OF THE DANUBE COMMISSION CONCERNING THE
TECHNICAL AND NAVIGATIONAL CHARACTERISTICS OF PUSHED CONVOYS**

I. INTRODUCTION

The present Recommendations, which specify technical and navigational requirements for pushed convoys, contribute to increasing navigational safety and to creating favourable conditions for the development of push-towing. They generalize the experience acquired by the Danube countries in that domain on which the uniform, minimum standards stemming from the need to ensure navigational safety are based.

II. GENERAL PROVISIONS

2.1. Objectives and scope

The purpose of these Recommendations is to define the technical and navigational characteristics of pushed convoys.

These Recommendations shall apply on the Danube to all pushed-convoy vessels that will be built after the entry into force of the Recommendations.

2.2. Terms and definitions

The terms used in these Recommendations are fully in accordance with the terms and definitions contained in the Basic Provisions relating to Navigation on the Danube (DFND) and other documents adopted by the Danube Commission.

2.3. Relations with documents in force and the DFND

The provisions of these Recommendations are fully in accordance with the DFND and the local rules established by the Danube States and special river administrations and with other documents in force in the domain of push-towing. The provisions of these Recommendations derive from those of the above-mentioned documents and contribute to their uniform application.

**III. TECHNICAL AND NAVIGATIONAL STANDARDS FOR PUSHED
CONVOYS**

The pusher shall always be sufficiently powerful and manoeuvrable to ensure safe upstream and downstream navigation for the pushed convoy; the technical and navigational characteristics of the pusher shall not be such as to hinder the movement of other vessels, in particular when passing through difficult sections (bends, shoals, bridges), and when overtaking, crossing or stopping.

3.1. Minimum speed

The pusher shall be able to maintain the convoy at a minimum speed of not less than 12 km/h in still water.

This condition is not required for pushers operating only in ports and roads.

3.2. Stopping distance and stopping time

The pusher shall be sufficiently powerful to bring the pushed convoy to a complete stop relative to the shore under the following conditions:

The distance travelled before stopping shall not exceed:

- upstream: 200 m or one convoy length;
- downstream: 600 m or three convoy lengths.

The stopping time of a convoy shall not exceed:

- upstream: three minutes;
- downstream: six minutes.

3.3. Manoeuvrability while going ahead

A pushed convoy shall have good manoeuvrability while going ahead, ensured by the pusher's capacity to keep a straight course and to change that course rapidly if necessary. The time required to put the rudder over from 40° on one side to 35° on the other using the main steering gear shall not exceed 28 seconds at a maximum speed of travel.

3.3.1. Capacity of the pusher to keep the convoy on a straight course

The time for which the convoy may be held on a straight course without the use of rudders shall be not less than one minute on average.

The number of course corrections required to keep the convoy on a straight course for five minutes shall be not more than five.

3.3.2. Capacity of the pusher to change the convoy's course rapidly

The time required to turn the convoy from a straight course by 10° and return it to the original straight course by putting the rudder over by $\pm 20^\circ$ shall not exceed five minutes when travelling upstream. In the case of evasive action, the distance required across the bed of the waterway shall not exceed 0.4 convoy lengths.

3.4. Manoeuvrability while going astern

A pushed convoy shall have adequate manoeuvrability while going astern and shall be capable of moving in the desired direction both when manoeuvring to stop and when prolonged movement astern is required for navigating reasons.

3.5. Capacity to effect lateral movement

The pusher shall, as far as possible, be capable of moving the convoy laterally, in a direction perpendicular to its axis, when, in the passage through narrows, shoals or bridges, during locking, overtaking or manoeuvring in ports or in accident situations, such a movement becomes necessary.

3.6. Turning time and turning space

The time required to turn a convoy through 180° shall not exceed 10 minutes. The turning space of the convoy shall not exceed 1.5 convoy lengths across the bed of the waterway, while drift

downstream shall not exceed three convoy lengths. All means of ensuring turning manoeuvres should be used for this purpose.

METHODS FOR TESTING PUSHED CONVOYS

These methods of conducting tests and measurements to determine the technical and navigational characteristics of pushed convoys contained in Part III of the outline for the Recommendations on the subject, are designed to establish uniform principles for full-scale testing of pushed convoys.

Prior to testing, basic data relating to the pushed convoys and navigating conditions in the test area need to be determined.

During testing, a minimum of two sets of measurements of the parameters in question shall be taken, and the average value for each characteristic calculated. The analysis of the results obtained for each characteristic shall be based on the conclusions of the tests and the final values for the specific pushed convoy or standard convoy can thus be determined.

A. Basic data on navigating conditions in the test area

Full-scale tests shall be carried out on a straight section of the river where the flow is uniform and there is sufficient channel width and depth. Testing shall be conducted as far as possible, in calm weather or with wind speed not exceeding force two on the Beaufort scale.

The bank of the test area shall be equipped with intersection markers and, as far as possible, with range markers or buoys fitted with radar reflectors. The intersection markers shall be placed at specified distances from each other.

The characteristics of the navigating conditions at the test area shall include:

- location of the section (from km ... to km ...) and its length;
- date (day, month, year) and time of the test;
- weather conditions, visibility, wind speed and direction;
- water level at the nearest measuring post;
- average speed of current;
- average channel width;
- average channel depth.

B. Basic data on pushed convoys

Full-scale tests shall be carried out, as far as possible, with pushed convoys of maximum size navigating on the sector in question; the maximum dimensions shall be determined on the basis of practical experience, in the light of navigating conditions and the power and manoeuvrability of the pusher, while observing the conditions for navigational safety. On sections where regulations govern the dimensions of pushed convoys, the size of the pushed convoy shall not exceed the prescribed maximum. The formation of the convoy, the number of units and the amount of the cargo to be carried should be chosen according to whether the direction of navigation is upstream or downstream.

Pushed convoy vessels being tested shall as far as possible be of the same type and of identical draught.

The characteristics of a pushed convoy are determined by the following:

- configuration of the pushed convoy;
- size of the pushed convoy (L_{max} , B_{max});
- displacement, deadweight of the pushed convoy and amount of cargo carried;
- data on the pushed vessels (L_{max} , B_{max} , $T_{mean,eff}$, D_{eff} , Q);
- data on the pusher (L_{max} , B_{max} , T_{max} , N).

C. **Methods for testing the various technical and navigational characteristics of pushed convoys**

The distance and position of a pushed convoy during testing may be measured by means of range markers installed on the bank or by radar photography, whereby the images on the radar screen of the pusher are photographed at specific time intervals, or by any other means ensuring an accuracy of measurement of ± 10 m.

1. Speed

The speed of pushed convoys shall be measured moving both upstream and downstream, taking the following into account:

(a) Preparation for testing:

- the length of the section to be navigated shall be, as far as possible, not less than 2 km;
- before measurements are taken, the pushed convoy shall travel a distance of one kilometre with the pusher's engines at full power;
- when the pusher's rudders are put over during testing, the deflection of the rudder blade shall not exceed $\pm 5^\circ$.

(b) Values to be measured:

- distance travelled;
- time required to travel this distance;
- revolutions of the main machinery.

(c) Data to be calculated:

- speed of movement upstream relative to the bank;
- speed of movement upstream relative to the water;
- speed of movement downstream relative to the bank;
- speed of movement downstream relative to the water.

The measurements of speed shall be used to determine the minimum speed of a pushed convoy relative to the bank in km/h which meets the conditions for safety of navigation even when passing through sections of the channel which are difficult to navigate.

2. Stopping distance and stopping time

These values shall be measured for convoys moving both upstream and downstream.

- (a) Preparation for testing:
- Before testing begins, the pushed convoy shall travel a distance of one kilometre with the pusher's engines at full power;
 - When the pusher's rudders are put over during testing, the deflection of the rudder blade shall not exceed $\pm 5^\circ$;
- (b) Values to be measured:
- revolutions of the main machinery;
 - speed relative to the bank at the beginning of the tests;
 - time required:
 - to stop the engines when going full speed ahead;
 - to reverse the engines;
 - to put the engines into full speed astern;
 - time required for the engines running at full speed astern to bring the convoy to a stop relative to the bank;
 - distance travelled relative to the bank, measured in periods of time, before the convoy is brought to a stop.
- (c) Values to be calculated:
- total distance travelled before stopping relative to the bank when navigating upstream;
 - total time required to stop the convoy relative to the bank when navigating upstream;
 - total distance travelled before stopping relative to the bank when navigating downstream;
 - total time required to stop the convoy relative to the bank when navigating downstream.

3. Manoeuvrability while going ahead

The evaluation of manoeuvrability while going ahead at full speed (100% of the rated power of the main machinery), at medium speed (50% of the rated power) and at low speed (25% of the rated power), when navigating upstream and downstream shall consist in determining the ability of the pusher to keep the convoy on a straight course with minimum use of rudders, and its ability to change the convoy's course rapidly.

(a) Ability of the pusher to keep the convoy on a straight course

This ability shall be measured at full, medium and low speed upstream and downstream, and consists in the measurement of the following values:

- average time that a chosen course can be maintained without the use of rudders;
- number of turns of the rudder required to keep the convoy on the course specified and the average helm value over a period of five minutes.

(b) Ability of the pusher to change the convoy's course rapidly

This ability shall be measured at full and medium speed upstream, and consists in the measurement of the following values:

- time required to turn the convoy from its course by 10° by putting the rudder over 20° ;
- time required to return the convoy to its original course and turn it from that course by 10° in the opposite direction by putting the rudder over 20° on the opposite side;
- time required to return the convoy to its original course by putting the rudder over up to $\pm 20^\circ$;
- distance covered, by periods of time;
- lateral movement of the convoy from the original straight course.

While navigating downstream, the above measurements shall be taken in the same way, except that the rudder shall be put over in varying positions of up to 20° , 30° and 40° .

The following may be determined from the measurements:

- the time required to turn the convoy by 10° , to turn it back, to turn it by 10° to the opposite side and to return the convoy to its original course;
- the distance travelled and the maximum lateral movement of the convoy while changing course.

4. Manoeuvrability while going astern

Manoeuvrability while going astern, upstream and downstream, shall be ensured by:

- the reverse rudders, or
- the forward and reverse rudders, or
- the rudders and engines.

Measurements of manoeuvrability while going astern are taken in the same way as those of manoeuvrability while going ahead, keeping in mind the maintenance of the chosen course and the ability to return to the original course after a turn; the difference between the tests lies in the fact that for the measurement of the manoeuvrability while going astern, the rudders may be put over to any position and the engines used.

On the basis of the analysis of the test results, the time for which the pushed convoy can maintain manoeuvrability while going astern by putting over the rudders and using the engines shall be determined.

5. Turning time and turning space

Turning ability shall be tested with pushed convoys in formation for upstream and downstream navigation by the following manoeuvres:

- 180° turn downstream;
- 180° turn upstream.

When turning manoeuvres are effected, any position of the pusher's rudders, any speed and any mode of operation of the main machinery as well as the use of the bow rudder are permitted

in order to turn as tightly as possible. The method of effecting this manoeuvre (position of the rudders, direction of the engines) shall be indicated for each kind of turn, and the following measurements shall be taken:

- speed relative to the bank before the tests;
- time required to turn through 180°;
- width of turning space, measured perpendicularly to the direction of the current;
- length of turning space, measured according to the direction of the current.

On the basis of the analysis of the test results, the following data shall be determined for the different cases:

- time required to turn through 180°;
- ratio of the width of the turning space to the length of the pushed convoy $B_o/L = \dots$;
- ratio of the length of the turning space to the length of the pushed convoy $L_o/L = \dots$.

Appendix 5

MODEL OF A SERVICE RECORD

SERVICE RECORD

issued by:

Holder:

Name:

First name(s):

Born on:

Born at:

Nationality:

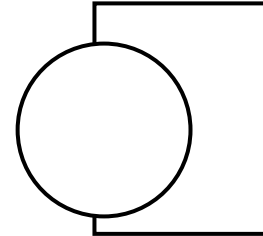

Photograph
of holder

The holder of this Service Record has given the following proof of identity:

- passport
- national identity card
- the document referred to below, with its official translation:

Description of the document:

No. of the document:

Document issued by:

Place, date, stamp and signature of the authority
issuing the service record

Previous Service Records and address of holder:

The first Service Record bearing the

Address of the holder of this Service Record
(insert changes of address here):

No.:

was issued by:

.....
.....
.....

on (date):

The previous Service Record bearing the

Remarks by the authority (for example,
details of a replacement record):

No.:

.....
.....

Date:

**HOLDER'S QUALIFICATIONS IN ACCORDANCE WITH SECTION 23-2
OF CHAPTER 23 "CREWS"**

Qualification: Qualification:
as from (date) as from (date)

Stamp, date and signature of the authority: Stamp, date and signature of the authority:

Qualification: Qualification:
as from (date) as from (date)

Stamp, date and signature of the authority: Stamp, date and signature of the authority:

Qualification: Qualification:
as from (date) as from (date)

Stamp, date and signature of the authority: Stamp, date and signature of the authority:

**CERTIFICATE OF FITNESS IN ACCORDANCE WITH
SECTION 23-3 OF CHAPTER 23 “CREWS”**

The holder of this Service Record qualifies on the basis of the medical certificate referred to in paragraph 19-3.1 of the above-mentioned chapter

issued by:

issued on:

fit

limited fitness

subject to the following condition(s):

.....
.....
.....

Period of validity:

SAILING TIME ON BOARD, NAME OF VESSEL:

Official number of vessel:

Type of vessel:

Flag:

Length of vessel in m*, number of passengers:

Owner (name, address):

Entry on duty of holder with the position of:

Entry on duty on (date):

Until (date):

Boatmaster (name, address):

.....

Place, date and signature of boatmaster:

.....

.....

Sailing time on board, name of vessel:

Official number of vessel:

Type of vessel:

Flag:

Length of vessel in m*, number of passengers:

Owner (name, address):

.....

Entry on duty of holder with the position of:

Entry on duty on (date):

Until (date):

Boatmaster (name, address):

.....

Place, date and signature of boatmaster:

* Delete as appropriate

Pages 7 – 23 are identical to page 6.

SAILING TIMES AND SECTORS COVERED DURING THE YEAR: 1995/96

Sailing times must correspond to the entries in the log!

| A | B | | | C | D | E | F | G |
|---|------------|-----------|------------|----------|----|----------|-----------|------------------|
| 1 7000281 | Rotterdam | Mainz | Vienna | 22.11.95 | 11 | 17.12.95 | 15 | Signature: Huber |
| 2 7000281 | Vienna | Mainz | Basel | 20.12.95 | 4 | 04.01.96 | 12 | Signature: Huber |
| 3 7000281 | Basel | | Rotterdam | 06.01.96 | 0 | 10.01.96 | 5 | Signature: Huber |
| 4 7000281 | Rotterdam | Antwerpen | Basel | 13.01.96 | 1 | 23.01.96 | 10 | Signature: Huber |
| 5 7000281 | Basel | | Antwerpen | 25.01.96 | 0 | 29.01.96 | 5 | Signature: Huber |
| 6 7000281 | Antwerpen | | Basel | 01.02.96 | 0 | 07.02.96 | 7 | Signature: Huber |
| 7 7000281 | Basel | Mainz | Bratislava | 09.02.96 | 5 | 22.02.96 | 9 | Signature: Huber |
| 8 7000281 | Bratislava | | Regensburg | 27.02.96 | 0 | 02.03.96 | 5 | Signature: Huber |
| 9 7000281 | Regensburg | Mainz | Rotterdam | 03.03.96 | 0 | 09.03.96 | 7 | Signature: Huber |
| 10 7000281 | Rotterdam | | Basel | 12.03.96 | 0 | 17.03.96 | 6 | Signature: Huber |
| Entry by the authority: total days of voyage taken into account on this page | | | | | | | 81 | |

Control stamp
Presented on (date) 15.12.1996

Signature and stamp of the authority

- Document complete yes no doubts arising from the presentation of the log (extracts)
- doubts in line(s) doubts arising from the presentation of any other appropriate documentary evidence

A-00735

SAILING TIMES AND SECTORS COVERED DURING THE YEAR

Sailing times must correspond to the entries in the log!

| A | B | C | D | E | F | G |
|---|---|---|---|---|---|---|
| 1 | | | | | | |
| 2 | | | | | | |
| 3 | | | | | | |
| 4 | | | | | | |
| 5 | | | | | | |
| 6 | | | | | | |
| 7 | | | | | | |
| 8 | | | | | | |
| 9 | | | | | | |
| 10 | | | | | | |
| Entry by the authority: total days of voyage taken into account on this page | | | | | | |

- 26 -

Control stamp
 Presented on (date)

Signature and stamp of the authority

- Document complete yes no doubts arising from the presentation of the log (extracts)
 doubts in line(s) doubts in line(s) of any other appropriate documentary evidence

A-00735

Pages 27 – 55 are identical to page 26.

Particulars and guidelines concerning the keeping of the Service Record

A. Particulars

The Service Record is an official document within the meaning of section 23-4 of chapter 23 “Crews”. The entry of incorrect or non-standard particulars may be sanctioned; in any case it is an offence. The competent authority is responsible for the particulars of a general nature (pages 2 to 5). The Service Record is valid only when it contains the official entries on page 2. It is not valid if these official entries are missing.

Who needs a Service Record?

Every crew member must be able to provide proof of his qualifications and fitness by means of a Service Record made out in his name. It is also required by persons wishing to obtain a licence so that they can provide proof of their sailing times and coverage of sectors on particular waterways. Crew members who hold a boatmaster’s licence are not required to continue to keep a Service Record. The holder of a licence or any other certificate of proficiency requires a Service Record only for the purpose of recording the sectors covered when his licence or certificate is not valid on those sectors and when he wishes to obtain the relevant document.

What obligations does a Service Record holder have?

The Service Record holder is the person in whose name the Service Record has been made out.

The Service Record should be given to the boatmaster on the first entry on service and should be presented to the competent authority at least once every 12 months as from the date on which it was established for the control stamp.

It is in the holder’s interest to ensure that the particulars entered in the Service Record by the boatmaster are correct and complete.

It is also in his interest to enable the competent authority to check his Service Record more easily by presenting the appropriate documents. If the competent authority observes that for certain voyages the particulars entered in the Service Record are incomplete or give rise to doubts which persist once the check has been completed, the voyages in question cannot be taken into account in calculating sailing time or as providing proof of the sectors covered.

What are the boatmaster’s obligations?

He is required to enter particulars concerning himself in the Service Record and note on a regular basis sailing times and sectors covered; he must keep the Service Record in a safe place until the end of the service or the term of the labour contract or any other arrangement. At the holder’s request, the Service Record must be given back to him immediately at any time.

Details of how the Service Record should be kept are given in the instructions below.

What obligations does the competent authority have?

It is required, but also has the right to check Service Records presented to it and to stamp them in accordance with its conclusions. It also has the right to request the presentation of logs, in full or extracts from them, or other appropriate documentary evidence.

B. Instructions concerning the keeping of the Service Record

1. General

- 1.1 The boatmaster is required to make regular entries in the Service Record.
- 1.2 Entries concerning the previous voyage shall be made in the Service Record before the start of the next voyage.
- 1.3 Entries made in the Service Record shall correspond to those of the log.
- 1.4 180 days of actual inland waterway voyage are counted as one year's navigation. Over a period of 365 consecutive days, a maximum of 180 days may be taken into account.

2. "Sailing time on board" (page 6 and following)

- 2.1 A new "Sailing time on board, name of vessel" section should be completed when the holder of the Service Record:

- begins his duties on board

or

- changes his duties on board the same vessel.

- 2.2 "Entry on duty" indicates the day on which the holder of the Service Record begins his activity on board. "Conclusion of duty" indicates the day on which the holder of the Service Record ceases his activity on board.

3. "Sailing times and sectors covered during the year ..." (page 24 and following)

Do not use page 24, begin on page 26.

- 3.1 The different voyages shall be entered in order to be taken into account for calculating sailing times and to provide proof of the sectors covered. The place of departure shall be entered under B, "Voyage from ..." and the place of destination furthest downstream or furthest upstream (final destination) shall be entered under "to ...". The k.p. may be given for greater accuracy. An entry under "via ..." is not required unless the vessel takes another waterway or returns from another waterway.
- 3.2 By derogation from 1.3 and 3.1, a monthly entry for the sectors covered, the number of voyages made (from the place of departure) and the total sailing period is sufficient in the case of regular duty on board a vessel over a short distance (e.g. 10 identical successive voyages) or in the case of shuttle services (e.g. day excursions for the carriage of passengers in local navigation, worksite traffic).

3.3 Under:

C = “Start of voyage”, the day of departure from the place of departure should be entered;

D = “Days interrupted”, the number of days during which the voyage has not continued should be recorded. In the event of a voyage without interruption, enter “0 (zero)”;

E = “End of voyage”, the day of arrival at the place of destination should be entered;

F = “Number of days of voyage”, the number of days between “Start of voyage” (C) and “End of voyage” (E), after deducting “Days interrupted” (D), should be entered.

3.4 A new line should be begun at each change of vessel.

3.5 Correspondence with the particulars entered in the log (see 1.3) exists if the particulars for the whole of the voyage from the day and place of departure to the day and place of arrival match and if the entry “Days interrupted” contains the total number of days on which the voyage is interrupted (e.g. loading, unloading, waiting) entered in the log.

3.6 On the page “Sailing times and sectors covered”, the competent authority shall complete the line “Entry by the authority: total days of voyage taken into account on this page”.

Appendix 6

CRITERIA FOR THE APPROVAL OF CLASSIFICATION SOCIETIES

Classification Societies seeking approval shall meet all the following criteria:

1. The Classification Society shall be able to document extensive experience in assessing the design and construction of inland waterway vessels, including vessels for the carriage of dangerous goods. The Classification Society shall have comprehensive rules and regulations for the design, construction and periodic inspection of inland waterway vessels, including vessels for the carriage of dangerous goods, which shall be published at least in Dutch, English, French or German and shall be continuously updated and improved through research and development programmes. The rules and regulations must not conflict with the provisions of international agreements in force.
2. The Classification Society shall publish its register of vessels annually.
3. The Classification Society shall not be controlled by shipowners or shipbuilders or by others engaged commercially in the design, manufacture, fitting-out, repair, operation or insurance of ships. The Classification Society shall not be dependent on a single commercial enterprise for its revenue.
4. The headquarters of the Classification Society or a branch authorised to give a ruling and to act in all areas incumbent on it under the regulations governing inland waterway transport shall be located in one of the UNECE Member States.
5. The Classification Society and its experts shall have a good reputation in inland waterway transport; the experts shall be able to provide proof of their professional abilities. They shall act on the responsibility of the Classification Society.
6. The Classification Society shall have a significant technical, managerial, support, inspection and research staff, in proportion to the tasks and the vessels classified and catering also for developing capability and updating the regulations. It shall have inspectors in UNECE Member States.
7. The Classification Society shall be governed by a Code of Ethics.
8. The Classification Society is managed and administered in such a way as to ensure the confidentiality of information required by a UNECE Member State.
9. The Classification Society is prepared to provide relevant information to a Member State.
10. The Classification Society's management has defined and documented its policy and objectives for, and commitment to, quality and has ensured that this policy is understood, implemented and maintained at all levels in the Classification Society.

11. The Classification Society shall have prepared and implemented and shall maintain an effective internal quality system based on the relevant parts of internationally recognized quality standards and complying with the ISO 9001 and ISO 14001 or EN 45004 (inspection bodies) and EN 29001 standards. The quality system must be certified by an independent body of auditors recognised by the administration of the State in which the Classification Society has its headquarters or branch, as provided for in paragraph 4, and which, inter alia, ensures that:

- (a) the Classification Society's rules and regulations are established and maintained in a systematic manner;
- (b) the Classification Society's rules and regulations are complied with;
- (c) the requirements of the statutory work for which the Classification Society is authorized are satisfied;
- (d) the responsibilities, authorities and interrelation of personnel whose work affects the quality of the Classification Society's services are defined and documented;
- (e) all work is carried out under controlled conditions;
- (f) a supervisory system is in place which monitors the actions and work carried out by surveyors and technical and administrative staff employed directly by the Classification Society;
- (g) the requirements of major statutory work for which the Classification Society organization is authorized are only carried out or directly supervised by its exclusive surveyors or through exclusive surveyors of other recognized Classification Societies;
- (h) a system for qualification of surveyors and continuous updating of their knowledge is implemented;
- (i) records are maintained, demonstrating achievement of the required standards in the items covered by the services performed, as well as the effective operation of the quality system; and
- (j) a comprehensive system of planned and documented internal audits of the quality related activities in all locations.

12. The quality system must be certified by an independent body of auditors recognised by the administration of the State in which the Classification Society has its headquarters or branch, as provided for in section 4.
